

FM 3-01.48

**DIVISIONAL AIR AND MISSILE DEFENSE
SENTINEL PLATOON OPERATIONS**

DECEMBER 2003

DISTRIBUTION RESTRICTION: Approved for public release; distribution is unlimited.

**HEADQUARTERS
DEPARTMENT OF THE ARMY**

**This publication is available at Army
Knowledge Online (www.us.army.mil)
and the General Dennis J. Reimer
Training and Doctrine Digital Library at
(www.adtdl.army.mil)**

DIVISIONAL AIR AND MISSILE DEFENSE SENTINEL PLATOON OPERATIONS

Contents

	Page
Preface	iii
Chapter 1 ORGANIZATION AND SYSTEM CAPABILITIES OF THE SENTINEL PLATOON	1-1
Mission	1-1
Organization	1-1
Responsibilities	1-6
System Capabilities and Limitations	1-9
Early Warning	1-13
Force Protection	1-18
Chapter 2 SENTINEL MANAGEMENT PLANNING, COMMAND, AND CONTROL	2-1
Management Planning	2-1
Employment Methods.....	2-1
Air and Missile Defense Employment Principles	2-2
Sentinel Employment Guidelines.....	2-3
Command and Control	2-4
Support Relationships	2-6
Military Decision-Making Process.....	2-7
Intelligence Preparation of the Battlefield Process	2-7
Planning Considerations	2-12
Troop-Leading Procedures	2-16
Backbriefs, Rehearsals, and Inspections	2-19
Chapter 3 SENTINEL COVERAGE IN OFFENSIVE AND DEFENSIVE OPERATIONS	3-1
Offensive Operations	3-1
Defensive Operations	3-6
Support of Light and Special Operations	3-11

Distribution Restriction: Approved for public release; distribution is unlimited.

* This publication supersedes FM 44-48, 21 September 1993.

Chapter 4	COMBAT SERVICE SUPPORT (LOGISTICS)	4-1
	Functional Overview	4-1
	Division Level	4-1
	Brigade and Battalion Level	4-3
	LOGPAC Operations	4-4
	Resupply Operations	4-11
	Personnel Services	4-16
	Medical Evacuation Procedures.....	4-17
	Echelons of Medical Care	4-22
Appendix A	AIR AND MISSILE DEFENSE ORDERS AND ANNEXES	A-1
Appendix B	RECONNAISSANCE, SELECTION, AND OCCUPATION OF POSITION	B-1
	Methods of Reconnaissance.....	B-1
	RSOP Sequence	B-2
Appendix C	CONTINUITY OF OPERATIONS	C-1
	Sentinel.....	C-1
	SINCGARS	C-2
Appendix D	SENTINEL MANAGEMENT CHECKLISTS	D-1
Glossary		Glossary-1
Bibliography		Bibliography -1
Index		Index-1

Preface

This field manual (FM) describes the organization and employment of the digitized air and missile defense (AMD) Sentinel platoon, sections, and teams. The term Sentinel incorporates the C² node, radar, and associated equipment. C² and C³ are interchangeable. This FM is to be used by the AMD Sentinel platoon leader and soldiers organic to Heavy and Light Divisional AMD battalions and AMD batteries supporting those respective Heavy and Light Divisions, Light/Heavy ACRs, and Separate Brigades.

This publication implements the following International Standardization Agreements (STANAGs):

STANAG	TITLE	EDITION
2014	Formats for Orders and Designation of Timings, Locations and Boundaries	9
2019	Military Symbols for Land Based Systems—APP-6(A)	4
2241	Land Operations—ATP-3.2	1
3880	Counterair Operations—ATP-42 (B)	3

The proponent for this publication is HQ TRADOC. Send comments and recommendations on DA Form 2028 to Commandant, US Army Air Defense Artillery School, ATTN: ATSA-DT-WF, Fort Bliss, TX 79916-3802. Unless this publication states otherwise, masculine nouns and pronouns do not refer exclusively to men.

Chapter 1

Organization and System Capabilities of the Sentinel Platoon

This chapter discusses the mission, organization, system capabilities, limitations, responsibilities, and early warning of digital divisional AMD Sentinel operations. The digitized Sentinel platoon provides 24-hour early warning (EW) to AMD battalions, batteries, platoons, sections, fire units, and AMD liaison officers (LNOs) which support the maneuver force. This digital early warning supports AMD elements in their mission to defeat enemy air attack platforms, deny enemy RISTA capabilities, and destroy low-level cruise missile threats. Digital early warning to AMD forces is necessary to minimize losses and maneuver effectively to win on the modern battlefield.

MISSION

1-1. The Forward Area Air Defense Command, Control, Communications, and Intelligence (FAAD C³I) system supports divisional AMD forces by facilitating the processing of critical C³I information to higher, adjacent, and lower units. The FAAD C³I function involves the detection, acquisition, and identification of helicopters, fixed-wing aircraft, cruise missiles, and unmanned aerial vehicles; the distribution and dissemination of C³I data among the AMD units and combined arms elements; the provision of early warning to the rest of the force; and the alerting of all forces to transiting enemy aircraft. To enhance functionality of the FAAD C³I system, it is integrated into and inter-operates with both the Army Battle Command Systems and AMD systems.

ORGANIZATION

1-2. This section describes the organization of the Sentinel platoon found in a digitized divisional AMD battalion. The unit MTOE provides detailed information on unit personnel and equipment authorizations. The digitized Sentinel platoon consists of a platoon headquarters, a maintenance section, and three C³I Sentinel sections. See Figure 1-1.

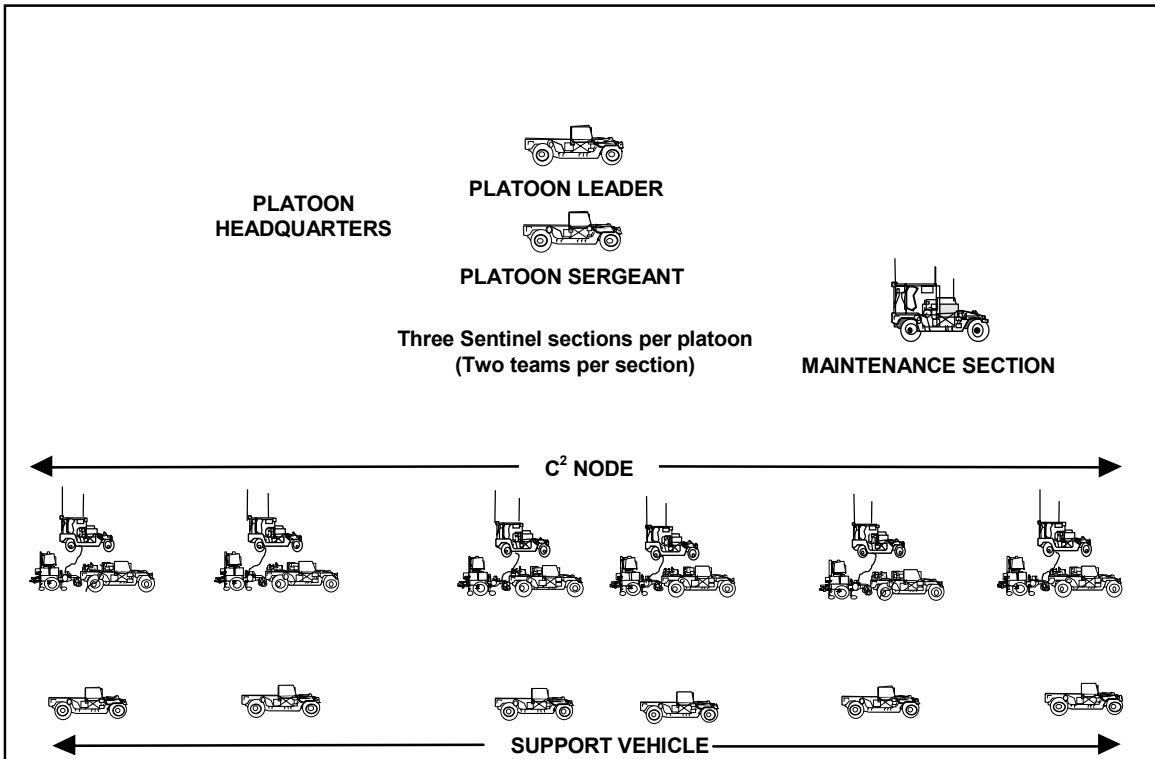

Figure 1-1. Sentinel Platoon Configuration

HEADQUARTERS

1-3. Headquarters provides the overall command and control of the platoon. Duties and responsibilities of headquarters personnel are addressed later in the chapter. Table 1-1 provides a listing of authorized personnel in the headquarters section, and Table 1-2 provides a listing of authorized equipment.

Table 1-1. Headquarters Section Personnel

QUANTITY	TITLE	RANK	MOS
1	Platoon leader	2LT	14B00
1	Platoon sergeant	SFC	14J40
1	Vehicle driver	PFC	14J10

Table 1-2. Headquarters Section Equipment

QUANTITY	ITEMS
1	Alarm, chemical agent, automatic: portable manpack M8A1
2	Truck utility: cargo/troop carrier 1-1/4 ton 4x4 W/E HMMWV
2	Navigation set: GPS receiver (PLGR)
1	Navigation set, satellite systems: AN/PSN-11
1	Night vision goggles: AN/PVS-5
4	Night vision goggles: AN/PVS-7B
1	PJH surface vehicle radio set: AN/VSQ-2 (V) 1 (PJHI)
1	HF radio set: AN/GRC-193A
1	Radio set: AN/VRC-91A
1	Radio set: AN/VRC-91D
1	Radio set: AN/VRC-92A
1	Radio set: AN/VRC-92D
1	Radio set: AN/VRC-92F
1	Radio set: AN/GRC-106
1	Radiac set: AN/UDR-13
1	Radiac set: AN/VDR-2
1	Radiac meter: IM-93/UD
1	Radiac meter: IM-174/PD
1	KY-99: MINTERM
1	Antenna group: OE-254/GRC
2	Cable telephone: WD-1/TT DR-8 1/2KM
1	Alarm, chemical agent, automatic: M22
4	Camouflage, screen support system: woodland/desert
4	Camouflage screen system: Ultra-lightweight radar scattering general-purpose
2	Camouflage screen system: Woodland light weight radar scattering without support system
1	Reeling machine cable hand: RL-39
1	Telephone set: TA-312/PT
2	Monitor chemical agent
1	Tape reader general purpose: KOI-18/TSEC
1	Power supply vehicle: HYP-57/TSEC
1	Mast antenna 10 meters: AB-903/G
2	Data transfer device: AN/CYZ-10
1	Electronic transfer keying device: KYK-13/TSEC
1	Net control device: KYX-15/TSEC
2	Computer set digital: AN/UYK
1	Antenna: RC-292
1	Battery case: Z-AIJ-E1
1	Alarm monitor group: NBC tactical vehicle/area warning

MAINTENANCE SECTION

1-4. The maintenance section is responsible for the operational readiness of all Sentinel-related equipment. Table 1-3 provides a listing of authorized personnel in the maintenance section, and Table 1-4 provides a listing of authorized equipment.

Table 1-3. Maintenance Section Personnel

QUANTITY	TITLE	RANK	MOS
1	Maintenance supervisor	SSG	35M30
1	System radar repairer	SGT	35M20
1	System radar repairer	SPC	35M10
1	System radar repairer	PFC	35M10

Table 1-4. Maintenance Section Equipment

QUANTITY	ITEMS
2	Truck, utility: cargo/troop carrier, 1 1/4 ton, 4x4, W/E (HMMWV)
2	Navigation set: GPS receiver
2	Radio set: AN/VRC-90A
2	Radio set: AN/VRC-90D
2	Multimeter digital: AN/PSM-45
4	Night vision goggles: AN/PVS-7B
2	Oscilloscope, DC 100MZ: AN/USM-488
2	Tool kit: electronic maintenance Sentinel
3	Tool kit: radar maintenance Sentinel
2	Test set radio frequency power: AN/USM-491
2	Test set: elect sys AN/PSM-95 for soldiers port on-system repair tool
4	Camouflage screen system: woodland lightweight radar scattering without support system
4	Camouflage screen support system: woodland/desert
4	Camouflage screening system: ultra-lightweight radar scattering general purpose
1	Cable telephone: WD-1/TT DR-8 1/2 KM
2	Data transfer device: AN/CYZ-10
2	Radiac set: AN/UDR-13
2	Radiac meter: IM-93/UD
1	Reeling machine cable hand: RL-39
1	Telephone set: TA-312/PT
1	Maintenance kit: supplemental (Sentinel)
2	Navigation set satellite system: AN/PSN-11
1	Alarm monitor group: (MICAD) NBC tactical vehicles/area warning
2	Computer set digital: AN/UYK
2	Radio set: AN/VRC-90F
2	Navigation set: GPS receiver

SENTINEL RADAR SECTIONS

1-5. The Sentinel platoon consists of three digitized Sentinel radar sections, two Sentinel teams per section. Teams normally work in pairs when deployed. These sections make up the FAAD C³I architecture of the Sentinel platoon. Table 1-5 provides a listing of authorized personnel in the sections. Table 1-6 provides a listing of authorized equipment in the sections.

Table 1-5. Sentinel Radar Sections Personnel

QUANTITY	TITLE	RANK	MOS
3	Section sergeant	SSG	14J30
3	Team chief	SGT	14J20
12	EWS operator	SPC	14J10
12	EWS operator	PFC	14J10

Table 1-6. Sentinel Radar Sections Equipment

QUANTITY	ITEMS
6	Air conditioner: 115V, AC, 1PH, 50-60 CY 9000 BTU
30	Alarm, chemical agent, automatic: portable, manpack, M8A1
6	Alarm: chemical agent automatic M22
12	Antenna group: OE-254()/GRC
6	Binocular: modular construction MIL scale reticle, 7x50MM W/E
12	Control, receiver-transmitter: C-11561
6	Battery case: Z-AIJ-E1
18	Cable telephone: WD-1/TT DR-8 1/2 KM
60	Camouflage screen support system: woodland/desert
6	Camouflage screen system: woodland, lightweight, radar scattering, without support system
6	Communications control set: AN/TSQ-183A
6	Data transfer device: AN/CYZ-10
3	Electronic transfer keying device ETKD: KYK-13/TSEC
12	Generator set: DED TM: 10 KW, 60 HZ, mounted on M116A2 PU-798
6	Generator set: DED skid-mounted, 10 KW, 400 HZ
6	Radar set: Sentinel AN/MPQ-64
6	KY-99: MINTERM
6	Indicator bearing distance heading (Patriot)
6	Night vision goggles: AN/PVS-5
36	Night vision goggles: AN/PVS-7B
18	PJH surface vehicle radio set: AN/VSQ-2
6	Radiac set: AN/VDR-2
6	Radio set: AN/GRC-213
6	Radiac set: AN/UDR-13
3	Alarm, monitor group: NBC, tactical vehicles/area warning
6	Radiac meter: IM-93/UD
6	Radiac meter: IM-174/PD
12	Reeling machine cable hand: RL-39

Table 1-6. Sentinel Radar Section Equipment (continued)

QUANTITY	ITEMS
6	Truck utility: heavy variant HMMWV, 4X4, 10000 GVW, W/E
3	Tape reader, general purpose: KOI-18/TSEC
6	Truck, utility: cargo/troop carrier 1 ¼-ton, 4X4, W/E (HMMWV)
6	Test set: electrical system AN/PSM-95 for soldiers port on-system rep tool teq
6	Power supply, vehicle: HYP-57/TSEC
6	Water heater: mounted/ration used on M1 tank & M2 fighting vehicles
60	Camouflage screening system: ultra-lightweight radar scattering general purpose
6	Radio set: AN/VRC-90F
6	Interrogation set: AN/TPX-56
6	Radio set: AN/GSQ-20
6	Radio set: AN/GRC-106
6	HF radio set: AN/GRC-193A
12	Radio set: AN/VRC-90A
12	Radio set: AN/VRC-90D
6	Radio set: AN/GRC-106
6	Navigation set: GPS receiver
6	Navigation set satellite systems: AN/PSN-11
12	Mast antenna, 10- meters: AB-903/B
6	Computer set, digital: AN/UYK
6	Common hardware maneuver control system

RESPONSIBILITIES

1-6. Providing digitized early warning to the force requires a team of trained and disciplined soldiers. Therefore, soldiers and leaders within the Sentinel platoon must be trained and knowledgeable on the entire digital early warning spectrum and serve as the FAAD C³I subject-matter experts to the air and missile defense force. Sentinel platoon personnel demonstrate their subject-matter expertise by providing timely and accurate early warning to the entire force 24 hours a day. They further support the force by integrating into the supported force planning process and assist with overall FAAD C³I management.

SENTINEL PLATOON LEADER

1-7. The Sentinel platoon leader is responsible for the morale, welfare, discipline, and training of his platoon, and for molding his platoon into an effective fighting force capable of performing its combat mission. He is further responsible for the operational readiness and accountability of all assigned equipment. In addition to his platoon leadership requirements, the Sentinel platoon leader is further responsible for executing a defined set of duties and responsibilities as the senior FAAD C³I expert in the AMD battalion. Because of this, he must be a senior lieutenant of proven competency and of the highest quality. Those duties and responsibilities are as follows:

- Participate in the division planning process and provide recommendations to the battalion S3 on the employment of Sentinel sections. See Chapter 2 for details on Sentinel employment planning.
- Assist the battalion S2 with integrating Sentinels into the division reconnaissance and surveillance plan.
- Assist the S3 in executing the C³I Sentinel management plan.
- Conduct a digital terrain analysis of all proposed Sentinel positions.
- Advise battalion personnel on digital communication links and assist the battalion signal officer with digital link management.
- Advise battery commanders on Sentinel employment and management when Sentinel sections are attached to AMD batteries.

SENTINEL PLATOON SERGEANT

1-8. The C³I Sentinel platoon sergeant is second in command of the C³I Sentinel platoon. He ensures the C³I Sentinel platoon is trained to accomplish its combat mission. The C³I Sentinel platoon sergeant is responsible to the platoon leader for the training, logistics, and discipline of the C³I Sentinel platoon. He coordinates all logistical and maintenance support the platoon requires. The platoon sergeant must work closely with the platoon leader to ensure unity of effort. He must be proficient in all of the tasks normally accomplished by the platoon leader and be prepared to accept platoon leader responsibilities in his absence. Additionally, the Sentinel platoon sergeant is responsible for executing the following duties and responsibilities:

- Assist the platoon leader with Sentinel employment planning.
- Coordinate and integrate GS Sentinel teams into supported force logistical plans.
- Advise battery commanders and first sergeants of Sentinel team logistical requirements, and assist with battery CSS planning when teams are attached to AMD batteries.
- Coordinate for the distribution of IFF codes to all Sentinel teams.

SENTINEL SECTION SERGEANT

1-9. The C³I Sentinel section sergeant is responsible to the platoon leader and platoon sergeant for the training, maintenance, discipline, and tactical employment of his C³I Sentinel teams. The section sergeant designates the area for positioning the C³I Sentinel teams per guidance from the S3, platoon leader, or battery commander when attached to a divisional AMD battery.

1-10. Based upon higher echelon orders, the section sergeant selects tentative positions for C³I Sentinels and approves positions upon confirmation from individual team chiefs. He coordinates with the AMD battery for supply and maintenance support of his teams and is responsible for the maintenance of all assigned equipment. He ensures the digital broadcast of air threat early warning to the divisional AMD battalion, batteries, platoons, sections, fire units, and AMD LNOs in his broadcast sector and zone. Finally, he executes the Sentinel employment plan as specified. Additional duties and responsibilities include the following:

- Ensure Sentinels are properly networked to pass a digital air picture to supported elements.
- Coordinate and integrate Sentinel positions into supported force scheme of maneuver.
- Verify that IFF codes are properly loaded into each Sentinel.
- Coordinate external issues to include force protection, logistics, casualty evacuation, and other requirements with supported forces.
- Based upon METT-TC, coordinate for engineer support and security augmentation to develop and execute site security for the individual Sentinels.
- Serve as the FAAD C³I SME to the AMD battery commander when attached. Advise the battery commander on Sentinel planning, employment, and digital link management.

1-11. Until the MTOE can be adjusted to accommodate personnel and vehicle shortages, the supported AMD battery must assume a majority of the Sentinel section sergeant's responsibilities. The following section sergeant responsibilities are performed by the first sergeant and battery XO/commander:

- AMD battery first sergeant:
 - Coordinate maintenance and DA 5988-E turnaround to include total responsibility for recovery of Sentinel equipment to BSA and coordination of contact teams.
 - Coordinate CASEVAC for Sentinel teams.
 - Implement a plan to resupply Sentinel section.

Logistics, maintenance, and CASEVAC support can be coordinated either directly from the battery, the GS platoon sergeant, or the DS platoon supporting a task force.

- AMD battery XO/commander:
 - Coordinate for Sentinel security/force protection during brigade MDMP.
 - When operating with maneuver task force coordination, needs to be directly tasked to DS AMD platoon leaders. This includes coordination for movement and any DS assets tasked with security or engineer support for Sentinel teams.
 - Develop a plan to get Sentinel section sergeant/team chief to brigade/task force order and rehearsal. This is the one area where an assumed risk has to be taken. It is imperative that section sergeants/team chiefs be present at orders and rehearsals.

AMD batteries must train with the Sentinel sections that support them and include Sentinel planning into their battery TACSOP. The Sentinel team is the key to successful FAAD C³I integration.

ORGANIZATIONAL LIMITATIONS

1-12. Current MTOEs dictate that Sentinel section sergeants serve as part of a Sentinel team. This impacts the section sergeant's ability to execute some internal requirements such as supervising Sentinel positioning, executing

logistics and CASEVAC operations, and providing general oversight of other Sentinel teams. Externally, the section sergeant is limited in his abilities to coordinate support from other forces and is limited in his ability to participate in the planning process, orders drills, and rehearsals. This limitation does not alleviate the section sergeant of his responsibilities. Leaders within the platoon must be creative in generating ways to overcome these limitations until such a time that MTOE changes are incorporated. Some recommendations may help alleviate this problem.

- Employ Sentinel platoon sergeants to assist section sergeants.
- Shuttle the section sergeant to the AMD battery during the planning process, orders drills, and rehearsals.
- Since Sentinels are almost always collocated with an adjacent unit, coordinate for external sources to provide CSS support to Sentinel teams.

1-13. Air defense early warning to the Armored Cavalry Regiment is limited in its application to the corps due to an insufficient number of Sentinel radars and JTIDS to cover the corps area of operations (three divisions). This limitation can be remedied with additional Sentinels equipped with a JTIDS, associated equipment, and 14J soldiers.

SYSTEM CAPABILITIES AND LIMITATIONS

1-14. The Sentinel radar is towed by a heavy HMMWV model 1097 with a mounted 10-kilowatt generator in the rear of the HMMWV. The digitized Sentinel/C² node is capable of 24-hour operations and can be located within 10 kilometers of the FLOT. It should have a clear field of view (360 degrees), no more than 60 kilometers from another Sentinel radar to ensure overlapping coverage (20-kilometer radar overlap), and should be placed away from power sources of similar radiating frequency bands to avoid interference. If two digitized Sentinel nodes must operate close together due to the mission, then one should counter-rotate to ensure no radar interference exists between them (Figure 1-2).

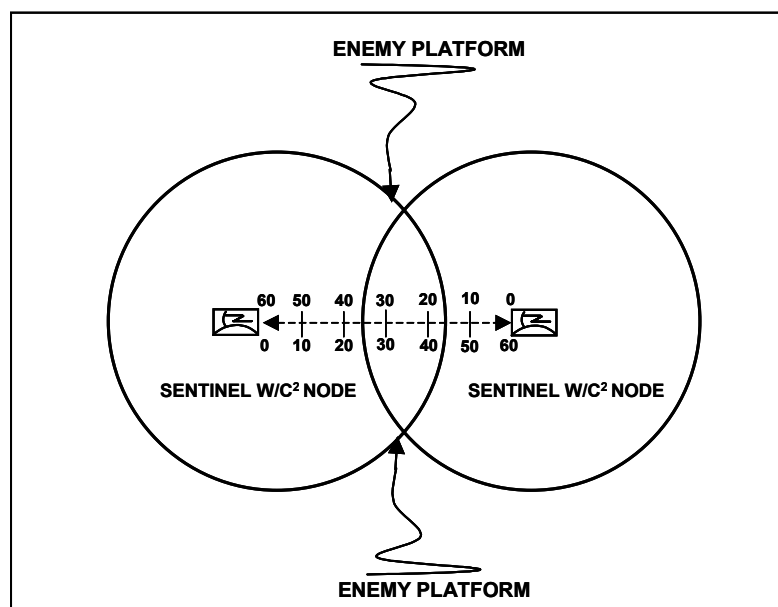

Figure 1-2. Deployed Sentinels

1-15. The Sentinel radar is an X-Band, medium PRF pulse-Doppler radar. Its extremely low noise design and Doppler signal processing result in exceptional ability to detect small, low-flying targets in clutter. Targets can be detected and tracked in all weather, day or night, under the most extreme battlefield conditions. The Sentinel can detect and classify rotary-wing aircraft, including hovering rotary-wing aircraft, at ranges beyond firing battery maximum weapon detection and engagement range in severe ECM. Due to its three-dimensional pencil beam and frequency-agile mode of operation, the Sentinel is difficult to detect and locate accurately, improving its survivability. See Figure 1-3.

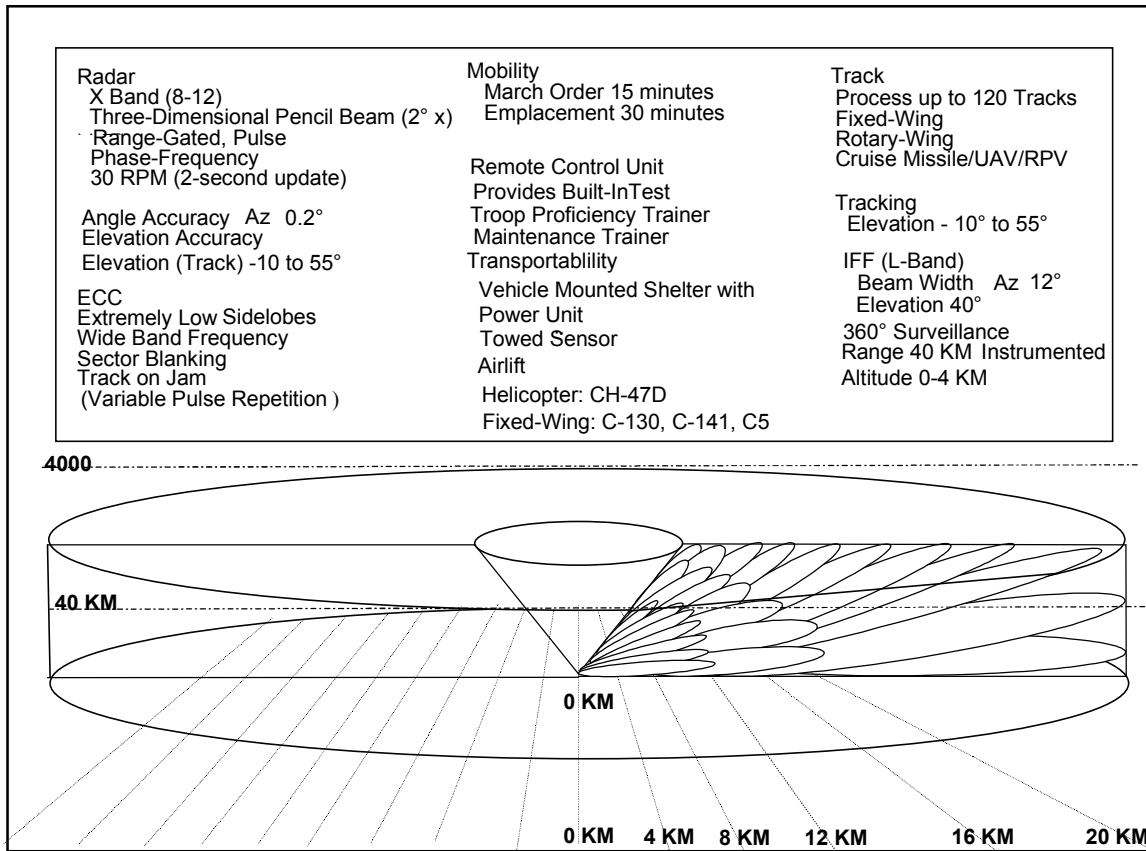

Figure 1-3. Sentinel Characteristics

ENHANCED TARGET RANGE ACQUISITION AND CLASSIFICATION

1-16. Two ETRAC modes are available to the operator:

- *Three-second rotation rate with full raster.* The operator selects this default mode under normal operating conditions.
- *Three-second rotation rate with low-altitude raster.* The operator selects this special mode only when directed by the team chief or higher authority due to an expected cruise missile threat to a particular asset.

DIGITIZED C² NODE

1-17. The digitized C² node is a heavy HMMWV model 1097 with a mounted shelter containing a transportable computer unit which displays the air picture, two EPLRS radios, two FM radios, and an uninterruptable power supply. The digitized C² node is the “voice” of each C³I Sentinel team. All communications, voice/data, and all air track data traffic is received and broadcast by the C² node. The digitized Sentinel node using EPLRS processes air tracks acquired by the Sentinel and correlates those air tracks with the tracks sent from the ABMOC. The Sentinels share their air picture with the other C² Sentinel nodes, the ABMOC, and the AD A²C². This process is referred to as “netted” C³I Sentinels. The digitized C² Sentinel node using EPLRS broadcasts early warning air tracks to its respective AMD battery, platoons, sections, fire units, and LNOs. See Figure 1-4.

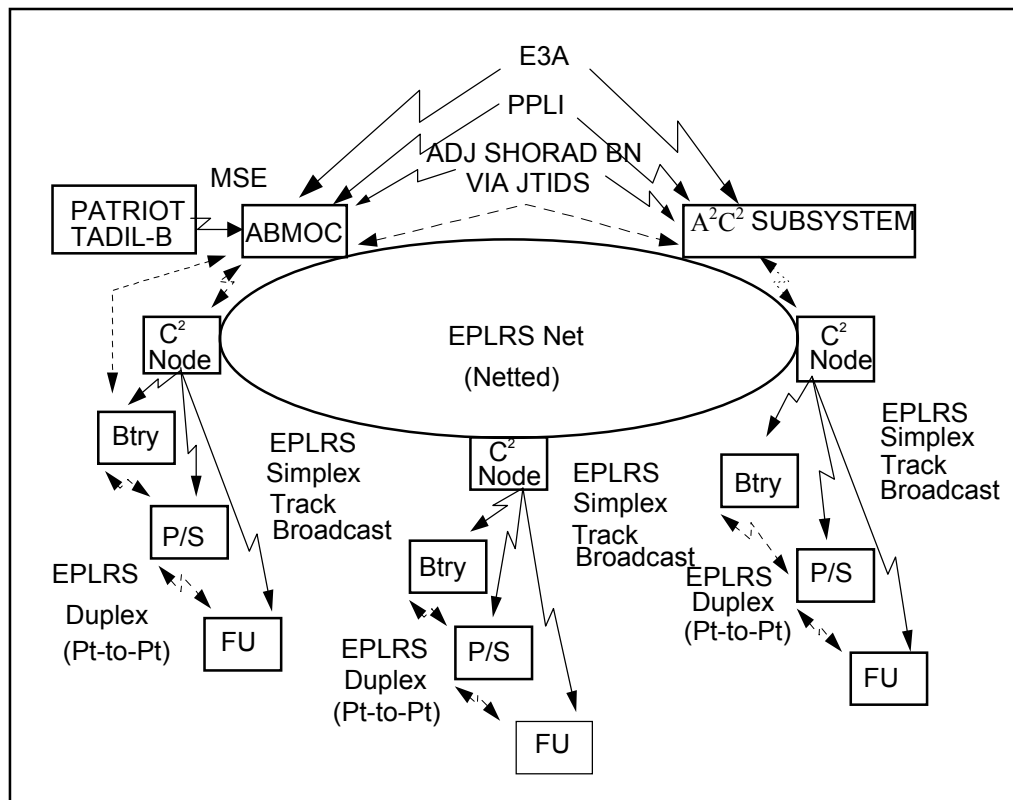

Figure 1-4. Netted Track Data

1-18. EPLRS connectivity is based on a needline library. The needline architecture is determined by the requirement to pass data to another element, hence the term needline. The supporting signal battalion in a division maintains the needline library. The AMD battalion’s signal officer and a 140A are required to ensure the appropriate needlines are established to support AMD digital operations. Needlines are not quickly adjusted, which is a problem when changing task organization. The modification of the needline architecture is a

complex process and needs to be identified in the planning process to ease transition.

1-19. It is imperative to understand the distinction between simplex versus duplex needlines. The simplex needline is a one-way connection. Within FAAD C³I this capability is used for the dissemination of air tracks. Duplex circuits are point-to-point two-way communications used in FAAD C³I for dissemination and acknowledgment of air defense warnings and battle management messages. The C² node will disseminate using a simplex needline. From battery level down, duplex EPLRS needlines will be used.

1-20. The digitized C² node equipped with only SINGARS is not able to “share” (or net) its air tracks with other C² nodes or with the AD A²C² and ABMOC. This is referred to as “unnetted” Sentinels. The digitized C² Sentinel node of the divisional AMD battalion using SINGARS broadcasts air tracks to the divisional AMD battery, platoons, sections, fire units, and LNOs for which the C² Sentinel node is providing early warning. See Figure 1-5.

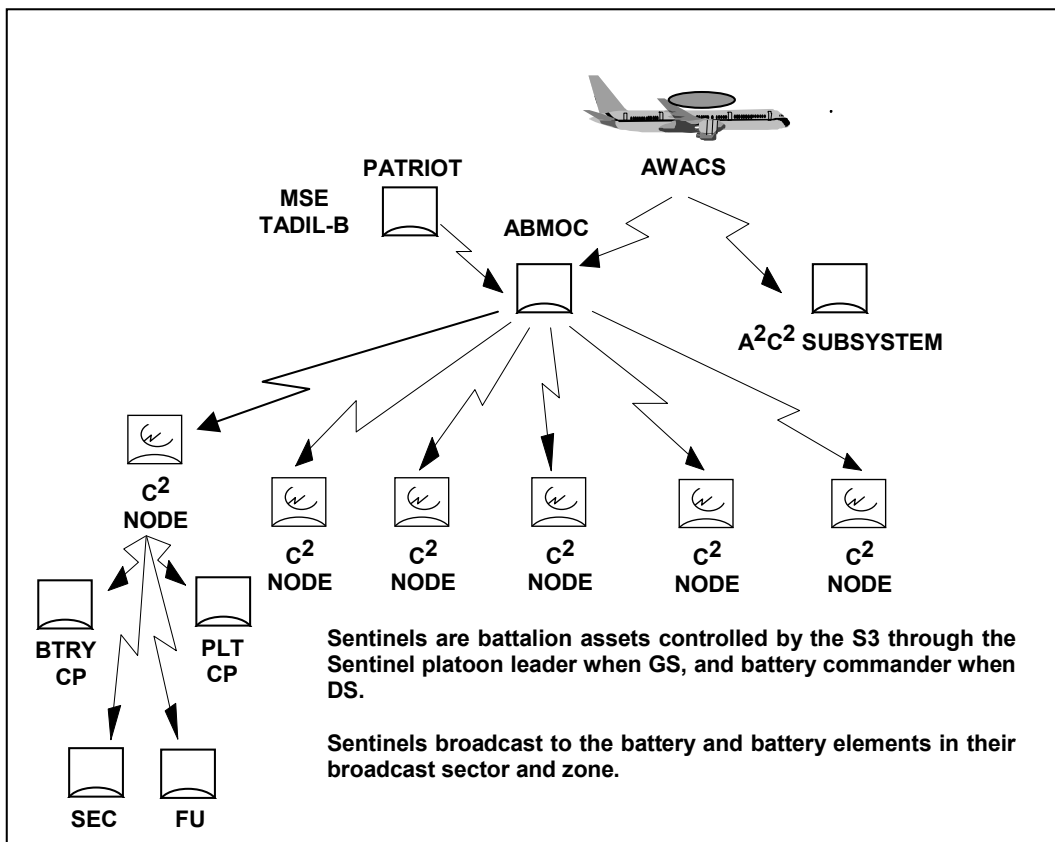

Figure 1-5. SINGARS Configuration

SENTINEL BROADCAST SECTOR

1-21. The digitized Sentinel node operator defines the Sentinel broadcast sector which is used to establish the volume of airspace within which air tracks are to

be broadcasted. The area defined in the SBS is referred to within AMD as the community of users.

1-22. The community of users within the SBS can be any grouping of batteries, platoons, sections, fire units, and AMD LNOs. The SBS will encompass the area of responsibility of the supported battery plus an area extended approximately 8-10 kilometers outside the defined battery area of responsibility. If no SBS is defined, then the software will construct a default SBS of 40 kilometers on a side centered on the Sentinel C² node location.

SENTINEL BROADCAST ZONE

1-23. Once the SBS is defined, the AMD C³I software automatically generates a Sentinel broadcast zone. The SBZ is a 60-kilometer extension of the SBS. Any air tracks present within the SBZ are broadcasted to the supported AMD elements. The SBZ may shrink as a result of communications saturation alleviation processing. See Figure 1-6.

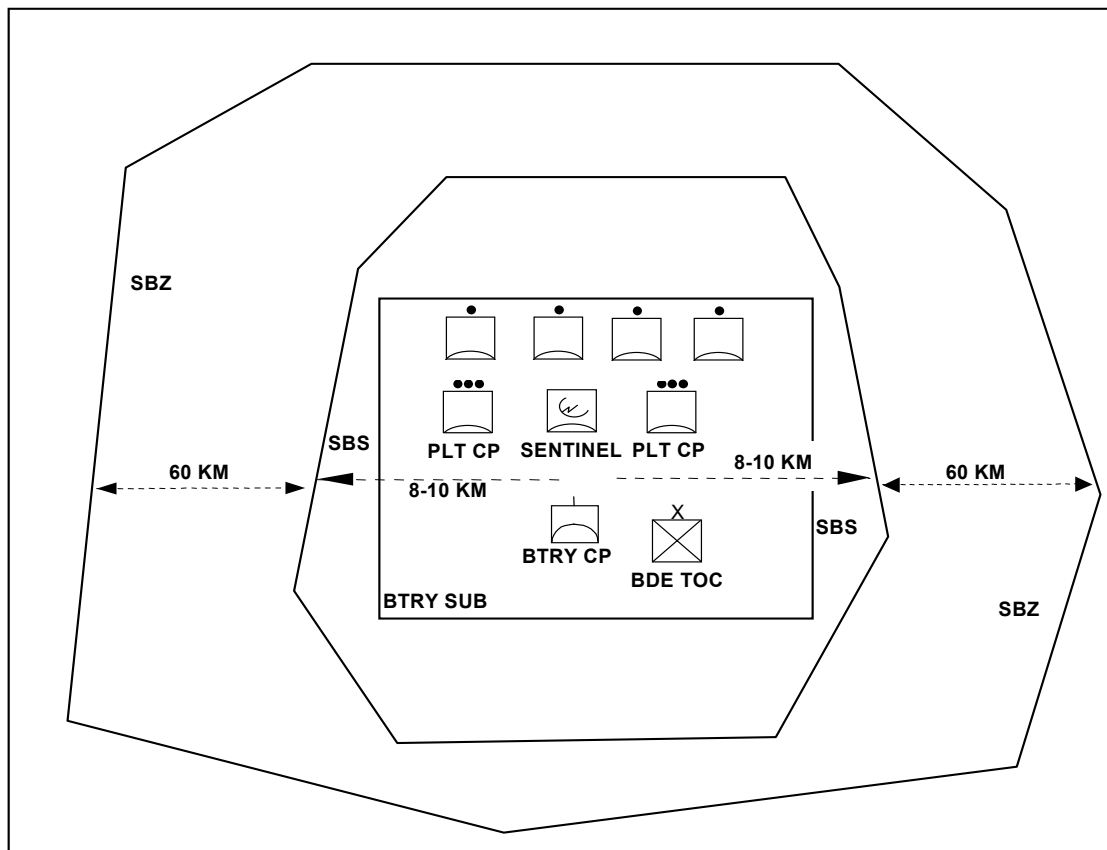

Figure 1-6. Sentinel Broadcast Sector/Zone

1-24. The digitized C² node operator will bring the C³I Sentinel system to an operational state to process AMD C³I data.

EARLY WARNING

1-25. The Sentinel platoon leader should be the resident expert concerning early warning. If air tracks are not received from the Sentinel teams, he should investigate potential terrain/LOS issues, EPLRS needline/EW frequencies, and other possible answers per the established TSOP. Although, typically, many of the problems encountered can be averted through prior planning, precombat checks, and precombat inspections. Early warning to the AMD elements normally originates at the ABMOC. The exception to this is the AMD batteries supporting a brigade slice or the ACRs and separate brigades. Their organic Sentinel platoon (two Sentinels) would broadcast only those air tracks originating with their organic Sentinels. If a JTIDS is furnished to one of the Sentinels, then external tracks can be correlated with its local data and broadcast to the AMD elements. In addition, in this configuration the platoon leader would have to assign track ID authority (coordinate with available A²C² elements) to one of the Sentinels. The Sentinel with the JTIDS would be a good choice. However, many JTIDS terminals will not get fielded to MTOE identified positions, because the radio is no longer in production.

1-26. Divisional AMD battalions in support of the light and heavy divisions have a six-Sentinel platoon. In that configuration, early warning starts with the ABMOC and A²C² subsystem receiving early warning simultaneously. The ABMOC will correlate those air tracks with the nearest Patriot source and any air track data (TADIL-J) input from other sources.

1-27. The ABMOC will then broadcast to the six Sentinels tactically located on the battlefield. The Sentinels will correlate those air tracks with their own local data and broadcast that correlated air picture to their respective AMD batteries, platoons, sections, fire units, and the LNOs in their Sentinel broadcast sector and zone. See Figure 1-7.

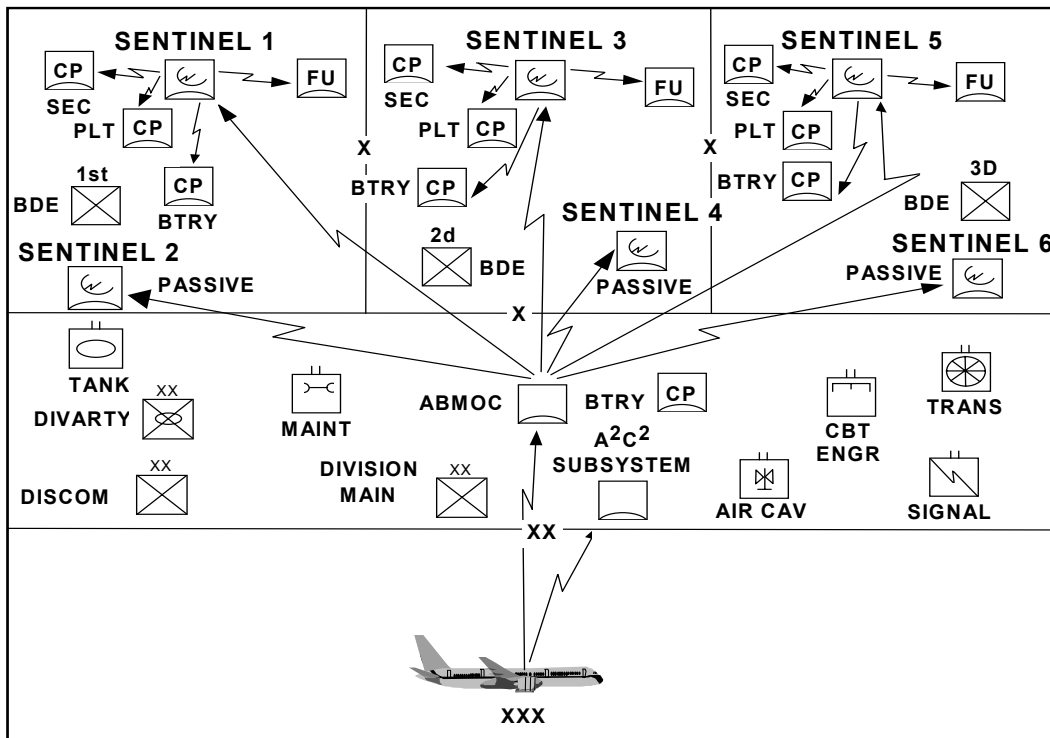

Figure 1-7. Division Early Warning

DIVISION (VOICE) EARLY WARNING

1-28. The division early warning net starts with the ABMOC receiving and correlating external tracks from outside sources (nearest Patriot, joint forces AWACS, Hawkeye, Navy, Marine) then broadcasted digitally to the six Sentinels tactically located on the battlefield. Some tactical missions due to METT-TC will require the FAAD C³I system to be less than 100 percent (no ABMOC/A²C² subsystem), and air tracks will be generated by the Sentinels only. Nonetheless, simultaneously, voice early warning will be broadcasted on the DEW net to the maneuver force. As the Sentinels are broadcasting digital EW to the AMD battalion elements, voice EW must be redundant, with the batteries broadcasting voice EW to the brigades, platoons to the battalions, and when required, the AMD sections to the maneuver companies and teams.

CORPS EARLY WARNING

1-29. Corps AMD battalion EW is passed over the corps early warning (CEW) net. The AMD brigade receives early warning from AWACS, other airborne platforms, Patriot units, host nation sources, or from an ADCS team at an adjacent AMD unit. The AMD brigade TOC passes the EW information to its AMD battalion ABMOC section. The battalion ABMOC correlates this information with other external track information received and sends the EW information over the AM net to battery elements. See Figure 1-8.

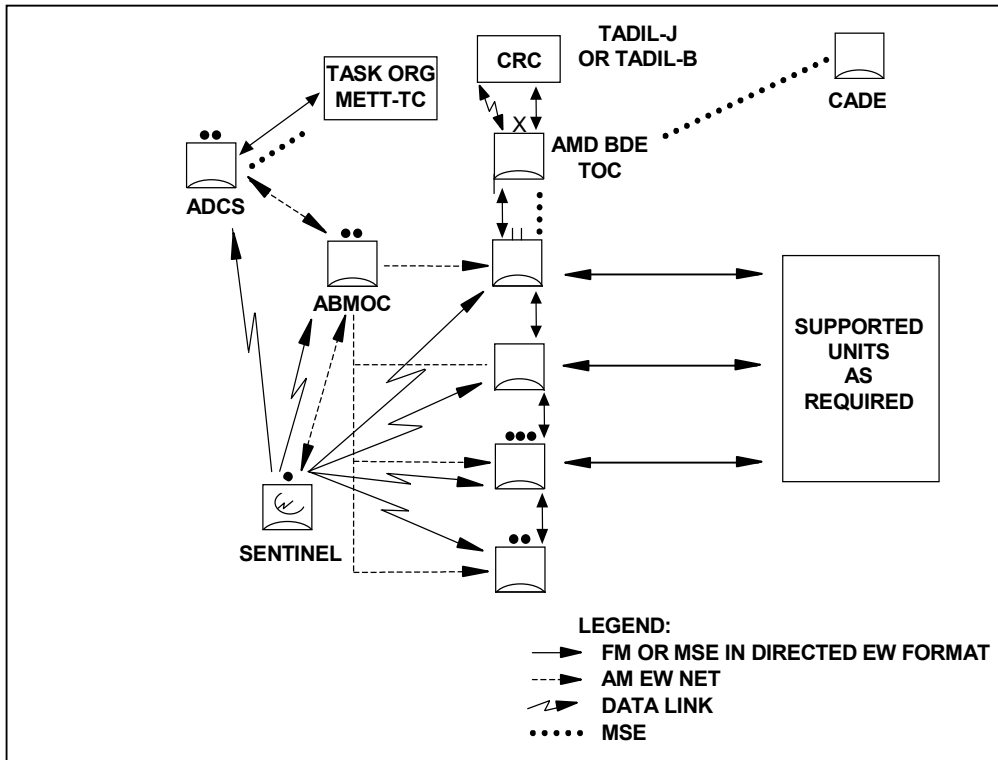

Figure 1-8. Corps Early Warning

DIRECTED EARLY WARNING

1-30. Directed early warning is designed to alert a particular unit, units, or area of the battlefield of an immediate or possible threat. It is passed over the supported unit command net or a net designated by the supported unit commander as flash precedent traffic. Directed early warning defines the local air defense warning and states whether the aircraft is friendly or unknown, a cardinal direction, and, if known, the most likely affected asset(s) within the supported force. For example, if an early warning source reports four enemy rotary-wing aircraft inbound from the east, and 1st Brigade is attacking along the eastern axis during a division attack, the ADO reports an LADW and directed early warning message: "Dynamite! Dynamite!" or "Red Air! Red Air! Four Hinds from the east against Axis Blue!" Dynamite is the LADW that alerts the division to attack, and the response according to the local SOP must be immediate. The AMD battalion TOC will broadcast directed early warning on the division command or O/I net and to the AMD battalion. When a threat to the supported force is identified, the ADO will transmit LADW on the supported force command net. When brigade ADOs receive early warning from the ABMOC or from the AMD Sentinels, they will direct early warning down on the supported unit nets.

1-31. Directed early warning must be quick, simple, and redundant in nature. It is imperative that all maneuver units receive early warning, especially those units that have only minimal air defense coverage. Unit SOPs will determine the exact procedures used but will include the following elements:

- Preface A method used to differentiate tracks.
- Identification Type of aerial platform, location, and time.
- Local Air Defense Warning Self-explanatory.
- Direction Self-explanatory.
- Size Few, many, or actual number.
- Affected asset Not sent in clear on unsecured nets.

LOW LEVEL AIR PICTURE INTERFACE

1-32. The low level air picture interface provides for the exchange of air track information with a source of external tracks via digital communications. LLAPI initially links air defense assets of the Federal Republic of Germany Army (and ultimately other NATO air defense assets) with FAAD C³I.

1-33. LLAPI consists of a shelter-mounted LLAPI subsystem interface and a FAAD C³I Sentinel. The two elements join together via a 30-meter long hardware interface.

1-34. The two subsystems receive air track data via their respective air defense systems (the FRG Army Air Defense Surveillance and Command and Control System and FAAD C³I). The LLAPI subsystem processes air tracks acquired by AADSACS into a data link format for transmission over the hardware interface to FAAD C³I. The LLAPI subsystem receives air tracks from the FAAD Sentinel node and processes such air tracks for dissemination to AADSACS over an AADSACS communications link. Air tracks from FAAD Sentinels are provided to the interfaced LLAPI if the air track is an organic FAAD Sentinel track or

indicated by a track quality greater than “0,” or if the track is within the adjacent LLAPI/FAAD system area of interest.

1-35. A LLAPI configuration can be established whenever a forward area FRG Army division and a US Army division share a common boundary. Depending on the availability of equipment, the FAAD Sentinel may either be dedicated to interface with LLAPI or LLAPI may interface with a FAAD Sentinel deployed closest to the FRG/US Army division boundary.

ADJACENT LLAPI OUTPUT FILTERS

1-36. The Sentinel node having a LLAPI will define an adjacent LLAPI output filter. The LLAPI operational concept calls for establishing an adjacent LLAPI output filter *approximately 30 kilometers parallel* to the common division lateral boundary. Air track reports will not be sent to an adjacent LLAPI until the operator has defined the adjacent LLAPI output filter.

1-37. The adjacent LLAPI output filter is defined by entering MGRS UTM coordinates which encompass the geographic area within which air tracks will be passed to the adjacent LLAPI. The adjacent LLAPI output filter will be determined by coordination with FRG Air Defense Command and Control personnel. If such coordination is not possible or practical, then a method to determine the coordinates to be entered is to take the common lateral boundary of the US/FRG division and extend its distance, according to the LLAPI operational concept, approximately 30 kilometers away from, and parallel to, the common boundary (as shown in Figure 1-9).

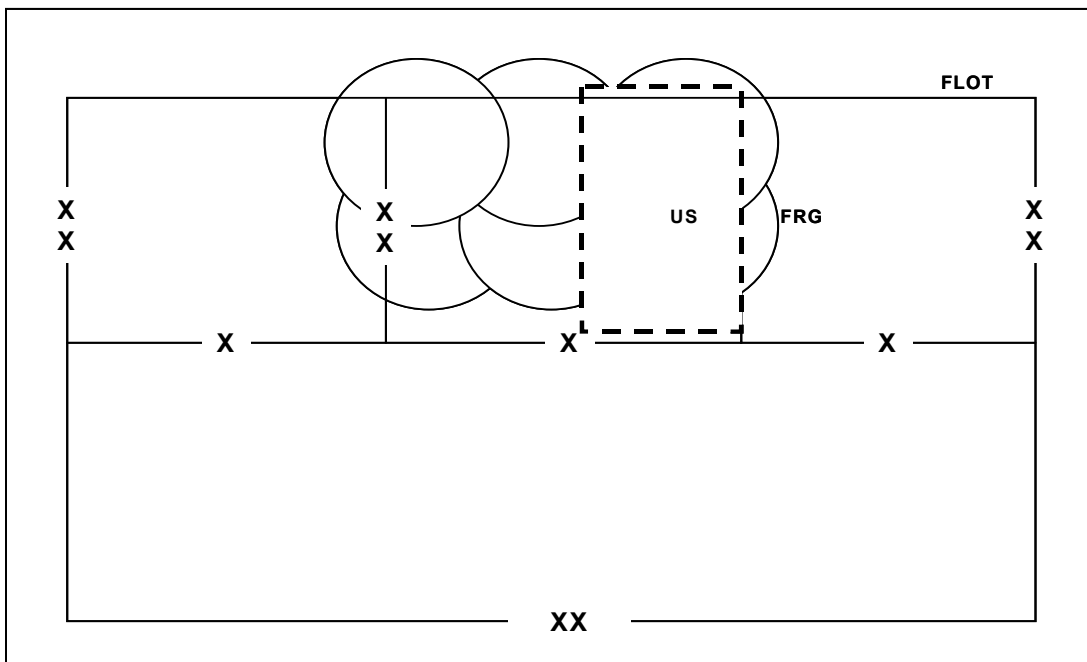

Figure 1-9. Adjacent LLAPI Output Filter

FORCE PROTECTION

1-38. Force protection needs to provide security for the high-value asset Sentinel radar teams. During offensive operations, the need for a Sentinel team to be placed on or near the line of departure can arise. In the defense, Sentinel teams covering a counter reconnaissance are positioned well forward on the battlefield.

1-39. Due to the requirement for LOS, operations in mountainous terrain dictate that Sensor/C² nodes be placed on the battlefield to properly cover the AMD elements with maneuver force and broadcast the FAAD C³I picture to the AMD elements in the Division. When a Sentinel team moves forward in the offense, they are usually OPCON for movement to a task force AMD battery. Security is provided, either by the rear elements of the task force or an element from the DS AMD platoon with the TF. Once the team arrives at their designated location, they are left with only small arms to defend themselves. When positioning a Division asset in proximity to the LD, security must be provided. Even Sentinel teams positioned 10 km behind the FLOT must be allocated additional security.

1-40. The Sentinel's rotating antenna must be clearly visible in order to accomplish its mission. This makes for an easily visible target for bypassed units or reconnaissance in the offense or for flanking units in the defense. Considerations must be made in order to counter a threat from crew-served weapons of 12.7 mm and above, a capability that Sentinel teams do not have. This type of support would most likely be necessary when a Sentinel section is attached to an AMD battery in support of a maneuver brigade. It is essential that this is captured during the planning process and put into the brigade order. Support of this type can come from many different sources, like the following:

- Brigade assets:
 - Military Police
 - Scouts
 - GS Avengers

- Battalion TF assets:
 - M1 Abrams
 - M2 Bradley
 - Linebacker/BSFV from DS Platoon

1-41. Force protection (safety and fratricide) is an issue that the Sentinel platoon leader must consider in all aspects of training and evaluation. Safety is a component of force protection. Sentinel leaders and soldiers use risk management to ensure that unnecessary risks are eliminated and that realistic training can be performed. Risk management assigns responsibility, institutionalizes the Sentinel platoon leader's review of operational safety, and leads to decision making at a level of appropriate risk. The objective of safety is to help Sentinel teams protect their limited combat power through accident prevention, which enables Sentinel teams to win fast and decisively, with minimum losses. Safety is an integral part of all combat, stability, and support operations. Safety begins with readiness, which determines a Sentinel team's ability to perform its METL to standard. During METL assessment, readiness standards are addressed.

- Sentinel soldiers with the self-discipline to consistently perform tasks to standard.
- Sentinel leaders who are ready, willing, and able to enforce standard.
- Training that provides skills needed for performance to standard.
- Standards and procedures for task preference that are clear and practical.
- Support for task preference, including required equipment, personnel, maintenance, facilities, and services.

1-42. Proper fluid replacement (hydration) is one of the most essential elements in heat injury prevention. Of particular note is the fact that the revised maximum hourly fluid intake should NOT exceed 1.5 quarts and the revised maximum daily fluid intake should not exceed 12 quarts. The newly revised fluid replacement chart (Table 1-7) describes the amounts of fluid replacement and work/rest cycles for acclimatized Sentinel soldiers undergoing training. Table 1-8 further describes the differences among easy work, moderate work, and hard work.

Table 1-7. Fluid Replacement Guidelines for Warm Weather Training (Applies to Average Acclimated Soldier Wearing BDU, Hot Weather)

Heat Category	WBGT Index, °F	Easy Work		Moderate Work		Hard Work	
		Work/Rest	Water Intake, Qt/hr	Work/Rest	Water Intake, Qt/hr	Work/Rest	Water Intake, Qt/hr
1	78-81.9	NL	½	NL	¾	40/20 min	¾
2 (Green)	82-84.9	NL	½	50/10 min	¾	30/30 min	1
3 (Yellow)	85-87.9	NL	¾	40/20 min	¾	30/30 min	1
4 (Red)	88-89.9	NL	¾	30/30 min	¾	20/40 min	1
5 (Black)	> 90	50/10 min	1	20/40 min	1	10/50 min	1

Notes:

- The work/rest times and fluid replacement volumes will sustain performance and hydration for at least 4 hours of work in the specified heat category. Individual water needs will vary ¼ qt/hour.
- NL = no limit to work time per hour.
- Rest means minimal physical activity (sitting or standing), accomplished in shade if possible.
- **CAUTION: Hourly fluid intake should not exceed 1½ quarts.**
- **Daily fluid intake should not exceed 12 quarts.**
- Wearing body armor add 5° F to WBGT Index.
- Wearing MOPP overgarment add 10° F to WBGT Index.

Table 1-8. Work Differences

Easy Work	Moderate Work	Hard Work
Drill and Ceremony	Walking Hard Surface at 3.5 mph, < 40 lb Load	Walking Hard Surface at 3.5 mph, ≥ 40 lb Load
Walking Hard Surface at 2.5 mph, ≤ 30 lb Load	Walking Loose Sand at 2.5 mph, no Load Calisthenics	Walking Loose Sand at 2.5 mph with > 30 lb Load
Weapon Maintenance	Patrolling	
Manual of Arms	Individual Movement Techniques (i.e. low crawl, high crawl)	
Marksmanship Training	Defensive Position Construction Field Assaults	

1-43. Risk management is a tool that addresses the root causes (readiness shortcomings) of accidents. It assists the Sentinel platoon leader and team chiefs in not only identifying what the next accident may be, but it also helps identify who may have the next accident. Risk management is a way to put more realism into training without paying the price in deaths, injuries, or damaged equipment.

1-44. Safety demands total chain of command involvement in planning, preparing, executing, and evaluating training. The chain of command has several safety-related responsibilities:

- Sentinel platoon leader, section sergeants, and team chiefs—
 - Seek optimum, not adequate, performance.
 - Specify the risk they will accept to accomplish the mission.
 - Select risk reductions provided by Sentinel team chiefs.
 - Accept or reject residual risk, based on the benefit to be derived.
 - Train and motivate Sentinel leaders at all levels to effectively use risk management concepts.
- Team chiefs—
 - Apply consistently effective risk management concepts and methods to operations they lead.
 - Report risk issues beyond their control or authority to their section sergeants.
- Individual soldiers—
 - Report unsafe conditions and acts and correct the situation when possible.
 - Establish a buddy system to keep a safety watch on one another.
 - Take responsibility for personal safety.
 - Work as a team member to implement safety performance measures.
 - Modify own risk behavior.

- Enhancement of basic soldier skills (Soldier’s Manual of Common Tasks and FM 7-8), promoting force protection and limitation of fratricide.

1-45. Risk management is a five-step cyclic process that is easily integrated into the decision-making process outlined in FM 100-14. The five steps are:

- Identify hazards. Identify the most probable hazards for the missions.
- Assess hazards. Analyze each hazard to determine the probability of its causing an accident and the probable effect of the accident. Identify control options to eliminate or reduce the hazard. The Army standard risk assessment matrix (Table 1-9) is the tool for assessing hazards.
- Develop controls and make risk decision. Weigh the risk against the benefits of performing the operations. Accept no unnecessary risks and make any residual risk decisions at the proper level of command.
- Implement controls. Integrate specific controls into OPLANs, OPORDs, SOPs, and rehearsals. Communicate controls to the individual soldier.
- Supervise and evaluate. Determine the effectiveness of controls in reducing the probability and effect of identified hazards to include follow up and after action review. Develop the lessons learned.

Table 1-9. Risk Management Steps

Military Decision Making Process	Step 1	Step 2	Step 3	Step 4	Step 5
	Identify Hazards	Assess Hazards	Develop Controls and Make Risk Decision	Implement Controls	Supervise and Evaluate
Mission Receipt	X				
Mission Analysis	X	X	X		
COA Development	X	X	X		
COA Analysis	X	X	X		
COA Comparison			X		
Orders Production			X		
COA Approval				X	
Rehearsal ¹	X	X	X	X	X
Execution and Assessment ¹	X	X	X	X	X

¹All boxes are marked to emphasize the continued use of the risk management process throughout the mission.

1-46. Fratricide is a component of force protection and is closely related to safety. Fratricide is the employment of weapons that results in unforeseen and unintentional injury or death to friendly personnel. Fratricide is by definition an accident. Risk assessment management is the mechanism with which incidences of fratricide can be controlled. The primary causes of fratricide are—

- Direct fire control plan failures. These occur when units fail to develop defensive and, particularly, offensive fire control plans.
- Land navigation failures. These result when units stray out of sector, report wrong locations, and become disoriented.

- Combat identification failures. These failures include gunners or pilots being unable to distinguish thermal and or optical signatures near the maximum range of their sighting systems and units in proximity mistaking each other for the enemy under limited visibility conditions.
- Inadequate control measures. Units fail to disseminate the minimum maneuver and fire support control measures necessary to tie control measures to recognizable terrain or events.
- Reporting communications failures. Units at all levels face problems in generating timely, accurate, and complete reports as locations and tactical situations change.
- Weapons error. Lapses in individual discipline lead to charge errors, accidental discharges, mistakes with explosives and hand grenades, and similar incidents.
- Battlefield hazards. Unexploded ordnance, unmarked or unrecorded minefields, FASCAM, and booby traps litter the battlefield. Failure to mark, remove, record, or anticipate these hazards increases the risk of friendly casualties.

1-47. Fratricide results in unacceptable losses and increases the risk of mission failure. Fratricide undermines the unit's ability to survive and function. Units experiencing fratricide observe these consequences:

- Loss of confidence in the unit leadership.
- Increasing self-doubt among team chiefs.
- Hesitation to use supporting combat systems.
- Over-supervision of units.
- Hesitation to conduct night operations.
- Loss of aggressiveness during fire and maneuver.
- Loss of initiative.
- Disrupted operations.
- General degradation of cohesiveness, morale, and combat power.

1-48. Protection of natural resources (environmental protection) has continued to become an ever-increasing concern to the Army. It is the responsibility of all unit leaders to decrease, and if possible eliminate, damage to the environment when conducting training. Environmental risk management parallels safety risk management and is based on the same philosophy as safety risk management. Environmental risk management consists of the following steps:

- Identify hazards. Identify potential sources for environmental hazards. An environmental hazard is a condition with the potential for polluting air, soil, or water and or destroying cultural and historical artifacts.
- Assess the hazard. Analyze severity of environmental degradation using environmental risk assessment matrix (Table 1-10). Severity of environmental degradation is considered when determining the potential effect an operation will have on the environment. The **risk impact value** is defined as an indicator of the severity of environment degradation. Quantify the risk to the environment resulting from the operation as extremely high, high, medium, or low, using the environmental risk assessment matrix.

Table 1-10. Environmental Risk Assessment Matrix

ENVIRONMENTAL AREA		RATING:					
UNIT OPERATIONS		RISK IMPACT					
Movement of heavy vehicles/systems		5	4	3	2	1	0
Movement of personnel and light vehicles/systems		5	4	3	2	1	0
Assembly areas activities		5	4	3	2	1	0
Field maintenance of equipment		5	4	3	2	1	0
Garrison maintenance of equipment		5	4	3	2	1	0
ENVIRONMENTAL RISK ASSESSMENT WORKSHEET							
	MOVEMENT OF HEAVY VEHICLES/ SYSTEMS	MOVEMENT OF PERSONNEL AND LIGHT VEHICLES/ SYSTEMS	ASSEMBLY AREAS ACTIVITIES	FIELD MAINTENANCE OF EQUIPMENT	GARRISON MAINTENANCE OF EQUIPMENT	RISK RATING	
Air pollution							
Archeological and historical sites							
Hazardous materiel/waste							
Noise pollution							
Threatened/ endangered species							
Water pollution							
Wetland protection							
Overall rating							
OVERALL ENVIRONMENTAL RISK ASSESSMENT FORM							
RISK CATEGORIES	RANGE	ENVIRONMENTAL DAMAGE		DECISION MAKER			
Low	0-58	Little or none		Appropriate level			
Medium	59-117	Minor		Appropriate level			
High	118-149	Significant		Division commander			
Extremely high	150-175	Severe		MACOM commander			

1-49. Make environmental risk decisions. Make decisions and develop measures to reduce high environmental risks.

1-50. Brief chain of command. Brief chain of command on proposed plans and pertinent high-risk environmental matrixes. Risk decisions are made at a level of command that corresponds to the degree of risk.

1-51. Implement controls. Implement environmental protection measures by integrating them into plans, orders, SOPs, training performance standards, and rehearsals.

Chapter 2

Sentinel Management Planning, Command, and Control

This chapter discusses management planning, command, and control for the employment of the Sentinel platoon. Divisional AMD command, control, communications, and intelligence (C³I) success is dependent upon detailed planning by the air defense officer at the battalion and battery levels and the Sentinel platoon leader, section, and team chiefs. Effective and efficient command and control of Sentinel assets and the execution of sound planning is vital to the success of the overall air and defense mission.

MANAGEMENT PLANNING

2-1. Thorough Sentinel platoon planning is critical to providing timely and effective air and missile defense throughout the division. The divisional AMD battalion S3 evaluates all aspects of mission; enemy; terrain; troops; time and civilian considerations; command and control; and logistical support. He does this before recommending an employment method to the AMD battalion commander.

EMPLOYMENT METHODS

2-2. Divisional AMD Sentinel platoons can employ Sentinels in one of three ways. The platoon as a whole can be employed in **general support to the division**, sections can be **attached to AMD batteries** in support of brigade combat teams, or sections can be employed in a **mixed mode** (a section attached to select BCTs and the remaining section GS to the division).

GS TO THE DIVISION

2-3. When providing GS to the division, the Sentinel platoon leader employs his platoon in sections (two teams per section) in support of the force as a whole. The Sentinel employment plan is generated as a result of the AMD battalion S2's air IPB. The S3 coordinates the selected Sentinel positions with the division staff and the AD A²C² element. Furthermore, Sentinel positions may be coordinated with the AMD battery commanders when planning calls for positioning Sentinels forward in brigade combat team areas of operation. In this method, the Sentinel platoon leader retains command and control of his entire platoon. This method is used most often during defensive operations.

ATTACHED TO AMD BATTERIES

2-4. Sentinel sections may be attached to each of the AMD firing batteries in support of divisional BCTs. The firing battery commander selects radar positions and informs the ABMOC and S3. The S3 coordinates and validates the Sentinel positions ensuring they support divisional reconnaissance and surveillance requirements and the overall scheme of maneuver. This method is preferred during most offensive operations and in defensive operations on canalized terrain. C² by the firing battery commander allows detailed coordination of movements in the main battle area, enhancing survivability and providing for better coverage. Attaching two Sentinels enables bounding movements in support of offensive operations. The Sentinel platoon leader normally assists the battery commander in support of the main effort BCT with employment planning and C² coordination when using this method.

MIXED EMPLOYMENT

2-5. When conducting a mixed employment, one or two Sentinel sections are attached to firing batteries while the other section or sections remain under the Sentinel platoon leader's control as in GS to the division. Other variations are METT-TC dependent. In this configuration, the Sentinel platoon leader normally operates from the ABMOC, but provides planning and employment assistance to the battery commander with the attached Sentinel section.

2-6. The Sentinel radar provides the foundation for digital early warning across the division. It is the single most important piece of equipment for the successful conduct of air defense operations in support of a maneuver force. The ability to plan and integrate the Sentinel radar effectively into the division/brigade scheme of maneuver will determine your success on the digitized battlefield.

AIR AND MISSILE DEFENSE EMPLOYMENT PRINCIPLES

2-7. Air defense forces fight per air defense principles of mass, mix, mobility and integration. These principles apply to both divisional AMD weapon systems and Sentinels.

MASS

2-8. Mass is the concentration of air defense combat power achieved by allocating sufficient fire units and EW assets to successfully defend a designated critical asset. Generally, digitized Sentinel teams will be the smallest tactical EW element assigned to provide surveillance for a specific critical asset, air avenue of approach, NAI, or TAI.

MIX

2-9. Mix is achieved through a balance between specific types of air defense systems, such as Stinger and Avenger. With Sentinels, mix is achieved through the establishment of netted joint and Army Sentinels to allow multiple means of detection for a specific area. Mixed forces cause the enemy to vary its attack approach because it faces a variety of air defense systems, rather than a single system. Creating a mix of air defense systems

greatly complicates the threat strategy, thus offering greater survivability for the defended asset.

MOBILITY

2-10. Mobility is characterized by the capability of individual air defense systems to move from asset to asset while providing the capability to fulfill their primary mission. The air defense package must be at least as mobile as the asset it defends. Defending static assets may also require quick movements to alternate positions.

INTEGRATION

2-11. Integration is the close coordination of effect and unity of action that maximizes air defense operational effectiveness. Integration necessitates effective command and control links among all echelons of command with the air defense commander, a full partner in planning and executing maneuver force operations. Successful integration helps to ensure that AMD Sentinels are in the right place at the right time to fully support the maneuver force.

SENTINEL EMPLOYMENT GUIDELINES

2-12. Sentinel employment guidelines are accepted means by which Sentinels may be employed to accomplish their mission. They are intended to serve as guidelines only and are used in conjunction with air defense employment principles. The guidelines that are used to employ the Sentinels are selected based upon an evaluation of the commander's intent, IPB, METT-TC, and asset priorities.

BALANCED COVERAGE

2-13. Balanced coverage is defined as providing Sentinel coverage in all directions for an asset or area. The asset or area may be battalion, brigade, or division-sized, such as a lodgment, brigade area of defense, or a flight landing strip.

WEIGHTED COVERAGE

2-14. Weighted coverage is defined as providing dense Sentinel coverage for the area that is most likely to be used by enemy airframes, and is most critical to the success of the supported unit's mission. This requires that the commander assume risk in other areas.

COVERAGE IN DEPTH

2-15. Coverage in depth requires the arraying of Sentinels throughout the depth of the battlefield to provide continuous coverage of ingressing and egressing air platforms. This is most often accomplished through the employment of a Sentinel mix.

EARLY DETECTION

2-16. Early detection is achieved by positioning Sentinels as far forward as the tactical situation permits to achieve the earliest possible detection of enemy airframes. In some situations, position Sentinel up to 10 kilometers from

the FLOT, but not within enemy artillery range. If the Sentinel is positioned in disregard of METT-TC, it will quickly get attrited by enemy SPF or indirect fire.

OVERLAPPING COVERAGE

2-17. Overlapping coverage is accomplished when the effective radar search sectors of adjacent Sentinels overlap by 20 kilometers. This allows the Sentinels to establish an uninterrupted band of radar coverage throughout the AO. The actual distance between Sentinels will fluctuate based upon ground clutter that will affect the actual coverage range of the Sentinel.

MUTUAL SUPPORT

2-18. Mutual support is accomplished when the effective search of two Sentinels extends to cover the entire dead space of the other Sentinel. This not only enhances coverage within the AO, but also facilitates survivability of the adjacent Sentinel.

COMMAND AND CONTROL

2-19. Placing an AMD unit under another unit forms unique command relationships. The relationships set the degree of control and responsibility a commander has for forces under his control.

2-20. Command responsibilities, responsibilities for service support, and authority to organize or reassign component elements of a supporting force remain with the higher headquarters or parent unit unless the authorizing commander specifies otherwise. See Table 2-1 for inherent responsibilities based on the type of command the Sentinel platoon is placed under.

COMBATANT COMMAND (COMMAND AUTHORITY)

2-21. COCOM is a nontransferable command authority exercised only by combatant commanders unless the national command authority directs otherwise. Combatant commanders exercise it over assigned forces. COCOM provides full authority to organize and employ commands and forces to accomplish missions. Combatant commanders exercise through subordinate commands, to include subunified commands, service component commands, functional component commands, and JTFs.

ATTACHMENT

2-22. Attachment is the placement of units or personnel in an organization where such placement is relatively temporary. Subject to the limitations imposed by the attachment order, the commander of the formation, unit or organization receiving the attachment has the responsibility to provide the attached units with sustainment support above its organic capability. The parent formation, unit, or organization will be responsible for the transfer, promotion of personnel, nonjudicial punishment, courts martial, and administrative actions, such as SIDPERS transactions and unit strength reporting.

OPERATIONAL CONTROL

2-23. Command authority that may be exercised by commanders at any echelon at or below the level of combatant is operational control. Operational control is inherent in combatant command (command authority). Operational control may be delegated and is the authority to perform those functions of command over subordinate forces involving organizing and employing commands and forces, assigning tasks, designating objectives, and giving authoritative direction necessary to accomplish the mission. Operational control includes authoritative direction over all aspects of military operations and joint training necessary to accomplish missions assigned to the command. Operational control should be exercised through the commanders of subordinate organizations. Normally this authority is exercised through subordinate joint force commanders and service or functional component commanders. Operational control provides full authority to organize commands and forces and to employ those forces, as the commander in operational control considers necessary, to accomplish assigned missions. Operational control does not, in and of itself, include authoritative direction for logistics or matters of administration, discipline, internal organization or unit training.

Table 2-1. Command Relationships

Inherent responsibilities are:	If Relationship is:			
	COCOM	Attached	OPCON	TACON
Has command relationship with:	Gaining combatant commander; gaining service component commander	Gaining command	Gaining command	Gaining Command
May be task organized by:	Gaining combatant commander; gaining service component commander	Gaining command	Gaining command	Parent unit
Receives logistic support from:	Gaining service component commander	Gaining command	Parent command	Parent unit
Assigned position or AO by:	Gaining component commander	Gaining command	Gaining command	Gaining command
Provides liaison to:	As required by gaining component commander	Per gaining command	As required by gaining component commander	As required by gaining component commander
Establishes and maintains communications with:	As required by gaining component commander	Gaining command	As required by gaining commander	As required by gaining component command and parent units
Has priority established by:	Gaining component commander	Gaining Command	Gaining Command	Gaining Command
Gaining command can impose further command relationship or authority of:	OPCON; TACON; direct support; general support; close support	Attached; OPCON; TACON; direct support; general support; close support	OPCON; TACON; direct support; general support; close support	Direct support; mutual support; general support; close support

TACTICAL CONTROL

2-24. Tactical control is the command authority over assigned or attached forces or commands, or military capability or forces made available for tasking. It is limited to the detailed and, usually, local direction and control of movements or maneuvers necessary to accomplish missions or tasks assigned. Tactical control is inherent in operational control. Tactical control may be delegated to, and exercised at any level at or below the level of combatant command. Tactical control allows commanders below combatant command level to apply force and direct the tactical use of logistics assets but does not provide authority to change organizational structure or direct administrative and logistical support.

SUPPORT RELATIONSHIPS

2-25. Support relationships define specific relationships and responsibilities between supporting and supported units. Refer to Table 2-2.

GENERAL SUPPORT

2-26. An AMD unit in GS provides support for the force as a whole. It is not committed to any specific element of the supported force. It does not support a specific unit within the larger unit's area of operations. An AMD unit in GS remains under the control of its higher AMD commander, and is positioned by its AMD commander. GS is commonly used to protect EAC, corps, or division-level assets.

GENERAL SUPPORT-REINFORCING

2-27. An AMD unit with a GS-R mission provides support for the force as a whole and secondarily augments the support provided by another AMD unit. AMD units with a GS-R mission have a primary responsibility to provide support to the force as a whole within a specific area, but must coordinate with the supported AMD unit to reinforce the coverage of assets in the area of operations.

REINFORCING

2-28. A reinforcing AMD unit augments the coverage of another AMD unit and strengthens the air and missile defense capabilities of the force. A reinforcing AMD unit is positioned to protect one or more of the reinforced unit's priorities as specified by the supported AMD commander. For example, a Sentinel platoon could reinforce the limitations of a Patriot battery's radar coverage.

DIRECT SUPPORT

2-29. In direct support, the supporting unit provides dedicated support to a specific unit. A DS AMD unit (with Sentinels) provides dedicated air and missile defense for a specific element of the force that has no organic air and missile defense. The supporting AMD unit coordinates its movements and positioning with the supported unit. The AMD weapons platoon, for example may provide DS to a mechanized task force. The weapons platoon will provide dedicated support to the task force and the weapons platoon leader will

position the platoon in conjunction with the task force commander's concept of the operation.

Table 2-2. Support Relationships

	Inherent Responsibilities							
	Relationship with:	Task-organized by:	Receives logistics from:	Positioned by:	Provides liaison:	Maintains commo with:	Priorities established by:	Gaining unit can further impose:
GS	Parent Unit	Parent Unit	Parent Unit	Parent Unit	Per Parent Unit	Parent Unit	Parent Unit	NA
GS-R	Parent Unit	Parent Unit	Parent Unit	Parent Unit	Per Parent Unit and reinforced unit	Parent Unit and reinforced unit	1. Parent Unit 2. Reinforced Unit	NA
R	Parent Unit	Parent Unit	Parent Unit	Reinforced Unit	Reinforced Unit	Parent Unit and reinforced Unit	1. Reinforced Unit 2. Parent Unit	NA
DS	Parent Unit	Parent Unit	Parent Unit	Supported Unit	Supported Unit	Parent Unit and Supported Unit	Supported Unit	NA

MILITARY DECISION-MAKING PROCESS

2-30. The military decision making process is the language used to solve tactical problems by commanders and staffs. The MDMP is a logical and pragmatic process that results in the development of an operation order. The successful integration of the ADO into the planning process results in a better-supported maneuver force and enhanced survivability for the air defense fire units and radars. The air defender serves as both a staff officer and commander in support of a maneuver force. It is critical for the ADO to be well-versed in the MDMP and his role in it. The MDMP starts with the receipt of the warning order from higher headquarters. The full decision making process begins upon receipt of the actual operation order or operation plan. See Appendix A for the proper warning order format.

2-31. Mission analysis allows the commander and staff to see the terrain, enemy, and their own forces within the context of the fight. This is called battlefield visualization. The critical intent of mission analysis is to provide an understanding of the supported units as well as the air defense mission, and an analysis of friendly weapon system capabilities and limitations (to include movement speed of wheeled vehicles with towed loads, radar range limitations, and dead space). The results of mission analysis are a defined tactical problem and the beginning of the process of determining feasible solutions.

INTELLIGENCE PREPARATION OF THE BATTLEFIELD PROCESS

2-32. The intelligence preparation of the battlefield is a systematic, continuous process of analyzing the threat and environment in a specific geographic area. IPB is the second step in mission analysis. IPB is designed

to support the staff estimate and MDMP. Most intelligence requirements are generated as a result of the IPB process and its interrelationship with the decision-making process. The IPB process consists of four steps described in the following paragraphs.

DEFINE THE BATTLEFIELD ENVIRONMENT

2-33. The battlefield environment is defined in order to further analyze the specific features of the environment or activities within it, and the physical space where they exist that may influence available COAs or commander's decisions. During this phase, the ADO identifies the area of operations (AO), area of interest (AI), and the battlespace from an air and missile defense perspective.

2-34. The AO is the geographical area where the commander is assigned the responsibility and authority to conduct military operations. The AO for the ADO extends vertically up to the maximum altitude of the friendly AMD systems and can include engagements horizontally beyond unit boundaries.

2-35. The AI is the area from which information and intelligence are required to permit planning or successful conduct of missions. The ADO's AI is generally larger than the AO or battlespace due to the great distances that threat air and missile systems can rapidly cover. The air AI extends vertically to cover the maximum service ceilings of trajectories of aircraft, UAVs, and missile systems. Horizontally, it extends to cover the maximum range of aircraft, UAVs, and missiles, to include threat airfields, forward arming and refueling points, navigation aids, and potential missile launch sites.

2-36. Battlespace is a physical volume that expands or contracts in relation to the ability to acquire and engage the threat. It varies in width, depth, and height as the commander positions and moves assets over time. The ADO's battlespace is the maximum effective range of his acquisition and weapon systems. For example, the maximum range of the Sentinel radar, given terrain restrictions, would be considered as the extent of the battlespace. If the Sentinel is receiving an external air picture JTIDS, ADSI, or Patriot link, the ADO's battlespace will be even larger.

DESCRIBE THE BATTLEFIELD'S EFFECTS

2-37. Battlefield effects are evaluated to determine how the battlefield environment influences both threat and friendly operations. A detailed analysis of both terrain and weather is conducted, and then evaluated to determine their effects on friendly and enemy COAs.

2-38. The military aspects of terrain are analyzed using the observation and fields of fire, cover, concealment, obstacles, key terrain, and avenues of approach methodology. The ADO analyzes the effects of terrain on threat air and support systems, and friendly weapon systems.

2-39. These aspects relate to the influence of terrain on visibility, target acquisition, and engagements. The ADO considers both visual and device-aided acquisition when conducting his analysis. Line-of-sight acquisition is essential for both air and missile defense weapon and surveillance systems,

and enemy air platforms. The air and missile defense workstation LOS analysis option provides planners with an excellent tool for identifying good observation positions for Sentinels. Once these positions are identified, ADOs should mark them for possible use during the operation or any contingency missions.

2-40. Cover provides protection from the effects of direct and indirect fires. Concealment provides protection from observation. The ADO identifies portions of the terrain such as hills, wood lines, and built-up areas that act as both cover and concealment for threat air platforms. These areas provide threat air platforms with the ability to mask, conduct pop-up attacks, and establish reverse slope loitering positions. The ADO also identifies terrain where threat air platforms can fly nap-of-the-earth flight profiles, maintaining concealment for rapid and undetected ingress into and egress from the AO.

2-41. Obstacles are any natural or manmade features that stop, impede, or divert military movement. The ADO identifies obstacles that impede the movement of Sentinels to positions on the battlefield (terrain contour, vegetation, water sources, and mine fields), and identifies obstacles that restrict NOE flight profiles (mountains, cities, trees, telephone and power lines).

2-42. Key terrain is defined as any locality or area, the seizure, retention, or control of which affords a marked advantage to either combatant. The ADO considers terrain that canalizes air threat systems, possible attack by fire, surveillance, loitering, FARP positions, and potential LZ, DZ, or forward air base locations as key terrain. In addition, positions that provide excellent surveillance by Sentinels are also considered as possible key terrain.

EVALUATE THE THREAT

2-43. Threat evaluation is conducted to determine threat force capabilities and the doctrinal principles and TTP threat forces prefer to employ. This step consists of developing threat models (doctrinal templates, description of preferred tactics and options, and identification of high-value targets) and identifying threat capabilities.

2-44. A doctrinal template illustrates the deployment pattern and disposition preferred by the threat's normal tactics when not constrained by the effects of the battlefield environment. ADOs consider the following when developing doctrinal templates for threat air operations:

- Types of threat.
- Typical ordnance delivery techniques.
- Air threat missions and objectives.
- Threat air order of battle.
- Typical sizes of threat packages.
- Locations of FARP and preferred flight profiles.

2-45. A description of preferred tactics and options is a narrative, matrix, or time-event chart describing the threat's preferred tactics. The ADO's description provides a detailed, time-sequenced explanation of the doctrinal

template, addresses phases of threat air operations, and describes preferred branches and sequels based on the success or failure of operations.

2-46. HVTs are assets that the threat commander requires for successful completion of the mission. ADOs develop HVT lists by mentally war gaming the operation and identifying assets that are critical to threat air success. Some typical HVTs include FARP, forward airfields, forward air controllers, UAV ground control stations, SEAD aircraft, and cruise missile-capable aircraft.

2-47. Threat capabilities are the broad COAs that the threat can take to influence the accomplishment of the friendly mission. They take the form of statements such as the following:

- The enemy has the capability to conduct coordinated, nighttime air and missile attacks.
- The enemy can generate up to 18 fixed-wing sorties and 24 rotary-wing sorties per day for up to three days.
- The enemy can conduct sustained 24-hour surveillance operations with their UAV force.

DETERMINE THREAT COURSES OF ACTION

2-48. This step consists of identifying the threat objectives, identifying available threat COAs, prioritizing COAs, and identifying initial collection requirements.

2-49. When identifying the threat objectives, the ADO must have a clear understanding of the objectives one echelon above and two echelons below the supported force. He will then analyze how threat air will support the accomplishment of those objectives.

2-50. When identifying available air threat COAs, the ADO considers how air will support the threat's most likely, most dangerous, and least likely COAs. Threat COAs are evaluated based on suitability, feasibility, acceptability, uniqueness, and consistency with threat doctrine along with recent threat trends. Air threat COAs are never determined in isolation from the maneuver forces they support.

2-51. The development of threat COAs generates a situation template, SITEMP narrative (or enemy synchronization matrix), and a listing of HVTs for each COA. Each COA is prioritized and analyzed for strengths, weaknesses, centers of gravity, and decisive points. The battlefield effects need to be incorporated as you generate these COAs (assumptions).

2-52. The event template is a tool developed to assist in indicating which COA the enemy will choose based on a series of named areas of interest. NAIs identify locations where specific activities will occur in conjunction with a specific COA. A series of NAIs is associated with each COA to assist in determining which COA is being adopted by the threat force. An event matrix that includes descriptions of anticipated activities, when they will occur, and assigns observation responsibility to specific elements accompanies the event template. These two products are used to build collection and R&S plans. ADOs develop air event templates focusing on specific air-related activities to

assist in determining threat COAs. This also assists in guiding the positioning of Sentinels that are used to monitor the air NAIs.

MISSION ANALYSIS COMPLETION

2-53. The ADO's ability to "see the enemy" provides the foundation for a successful plan. At the conclusion of mission analysis, a second WARNO is disseminated to subordinate elements to assist in the parallel planning process.

COA DEVELOPMENT AND ANALYSIS

2-54. The COA development phase develops a plan to accomplish the assigned mission with a focus on defeating the enemy and protecting the force. The end state is to integrate and synchronize all combat functions. COA development consists of: analysis of relative combat power, generation of options, arraying of initial forces, developing schemes of maneuver, and preparing COA statements and sketches. In addition, the ADO arrays AMD assets in conjunction with possible friendly COAs, develops AMD schemes of maneuver, and provides AMD input into the supported unit COA statements and sketches.

2-55. Once COAs are developed, they are compared and analyzed through a war game session. The war gaming session facilitates the synchronization of all BOSs and develops a shared vision of the battlefield. It also assists the commander and staff with maximizing combat power while protecting the force, visualizing and anticipating battlefield events, determining conditions and resource requirements, determining where and when to apply capabilities, and determining the most flexible COA.

2-56. War gaming is normally recorded using a synchronization matrix. The synchronization matrix developed during the war gaming process provides a detailed description of the operation, which allows the entire staff to share a common vision and coordinate specific actions with other staff members.

2-57. A decision support template and decision support matrix are also developed during war gaming. These products aid the commander and staff in making battlefield decisions. Combined, they provide a list of decision points, the location of the DPs, the criteria to be evaluated at the point of decision, the actions or options to occur, and identifies the unit that is to act and that has responsibility to observe the point. The DST and DSM also capture targeted areas of interest. TAIs are areas or points where successful interdiction will cause the threat to either abandon a particular COA or require him to use specialized engineer support to continue, where he can be acquired and engaged by friendly forces.

2-58. War gaming is an effective tool for the ADO. It enables the ADO to explain his use of direct support and general support assets, triggers for movement, and articulate the enemy air threat at a given time and place. Additionally, the flow of the battle and critical decisive points, which may trigger movements of GS assets (Avengers or Sentinels), is articulated to the division or brigade staffs. Finally, it provides an opportunity for the ADO to address force protection, movement sequencing and C² for the radars. For

example, “Team 1 will be OPCON for movement to TF 1-22 and will trail the Alpha Company/Team.” At the conclusion of the war gaming session, a third WARNO is disseminated to the subordinate elements.

PLANNING CONSIDERATIONS

2-59. Planning Sentinel employment is a complex process; however, proper planning is absolutely essential to the air defense mission. The following are some planning considerations for successful Sentinel management planning:

- The divisional AMD battalion or battery commanders must incorporate the Sentinel platoon leader or team sergeant in the planning process. At a minimum, he should attend the war gaming, which will provide him with a comprehensive vision of the fight.
- “See the enemy.” A thorough understanding of threat capabilities and trends is required. Enemy trends are depicted in the air event template and matrix and provide the ADO with a better visualization of the Sentinel movement scheme.
- The ADO must have an appreciation for the terrain. A thorough LOS analysis (preferably electronic) is conducted prior to deploying into a hostile theater. Develop a favorable air defense fire unit or radar position overlay. This overlay will facilitate C² for the commander in a fluid fight.
- Know the supported unit’s scheme of maneuver. The Sentinel’s position and movement scheme must be integrated with the maneuver force to successfully provide digitized early warning and force protection. Thus, if the Sentinel platoon leader is not integrated into the planning process, his platoon’s capability will not be used to full potential.
- Develop clearly defined triggers and orientation for the Sentinel radar. This can be a modified event template or a specific Sentinel platoon template. The triggers will allow radars to be in the “right position” at the “right time” to provide the necessary early warning. The use of aerial NAIs and AAA provide guidance to the Sentinel team chiefs on orientation.
- The communications architecture for the digitized air picture is a critical planning item. Planning distances for SINCGARS (5 to 7 kilometers) versus EPLRS (10 to 20 kilometers) are important. Failure to take the limitations of the communications system into account may result in Sentinels being in the “right place,” but unable to pass an air picture to anyone. A potential solution may be an EPLRS or SINCGARS retransmission system to support the data communications. Dependent upon METT-TC, it is often critical to mission success to emplace a retransmission network. Also, the autonomous versus correlated air picture requirements are different for the air defenders and the requirement to actually link your handheld terminal unit to a specific radar.
- Arranging force protection for radars is a critical task. Force protection must be addressed to the division or brigade combat team. Engineer support or security requirements in support of Sentinels

must become a standing operating procedure item and must be captured during the war gaming process.

- Sentinel teams movement planning is critical to providing effective early warning to the supported AMD force regardless of the mission. During the planning process, commanders must consider how long it will take a Sentinel team to travel to a position, emplace, and become operational. Detailed time phase lines are developed by the commander taking cross country mobility; obstacles; enemy disposition and composition; and emplacement and march order times into consideration. The ADO and Sentinel platoon leader must also consider the movement rate of the supported force when planning Sentinel employment, ensuring sufficient coverage is provided throughout the depth of the battlefield. In almost all cases, Sentinel teams will never move unsupported.
- Logistical support for Sentinel teams must be coordinated with the supported AMD force or the adjacent task force, or brigade combat team. Logistics is addressed in Chapter 4.
- Battalion or higher echelon dictates an emission control plan for Sentinels, based on METT-TC. The EMCON plan is designed to reduce the ability of the enemy to target the Sentinels by limiting the radar signature.

FAAD C³I SUPPORT FOR PLANNING

2-60. For digitized divisional AMD battalions, the MDMP process will be greatly enhanced with the aid of the C³I software. The C³I software allows for the scripting of simulated air tracks, fire unit positions, and battle management messages into a single node called the Simulation Control Source. This allows the ADO, Sentinel platoon leader, or section sergeants to script scenarios of expected air threat actions against deployed divisional AMD forces. It provides the planner with the ability to visualize the products of the planning process and refine the plan to ensure Sentinels and shooters are properly employed to defeat the threat.

SCENARIO GENERATION

2-61. The divisional AMD Sentinel SCS can be used to create new scenarios, to support analysis of current plans, to allow the planner to retrieve old scenarios to provide a historical perspective, and to allow the planner to edit or modify previously generated scenarios to meet current requirements. Scenarios can be designed consisting of a variety of information and data.

Configuration of Air and Missile Defense Forces

2-62. Generated scenario scripts of air and missile defense forces are previewed to evaluate the relative effectiveness of Sentinel positioning on specific terrain and weapon system line of sight against a defined air track threat. Furthermore, the script allows the planner to evaluate fire unit positioning relative to Sentinel positioning and compute the number of potential engagement opportunities available against a specific threat

scenario. This greatly assists leaders with employment planning in unfamiliar environments.

Air Track Script Generation

2-63. Air track scripts can be either added or modified to support any required scenario. The operator quickly scans through existing track scripts in the exercise script file and modifies selected air tracks; adjusts injection times; adds duplicates; or adds entirely new air track scripts as required. Air track scripts generally include the following information:

- Aircraft class (unknown/FW/RW/missile [default is FW]).
- Raid size (unknown/single/few/many [default is single]).
- Track source (Sentinel/Adjacent divisional AMD/E-3A [AWACS]/Sentinel/PPLI/TADIL-B [default is Sentinel]).
- Track Quality (01-15 with 15 being the highest quality).

2-64. The data for each track can consist of injection time; start location and up to 10 successive waypoints; altitude; setback distance for start and end of a turn; speed; and air track identity.

Quick View Screen

2-65. The SCS operator can review any track that has been defined. A graphic presentation of the over-the-ground trajectory is provided with waypoint data and start/end turn points. The primary purpose of this screen is to see if the track data entered is free of input errors and has produced the desired simulated flight path. See Figure 2-1.

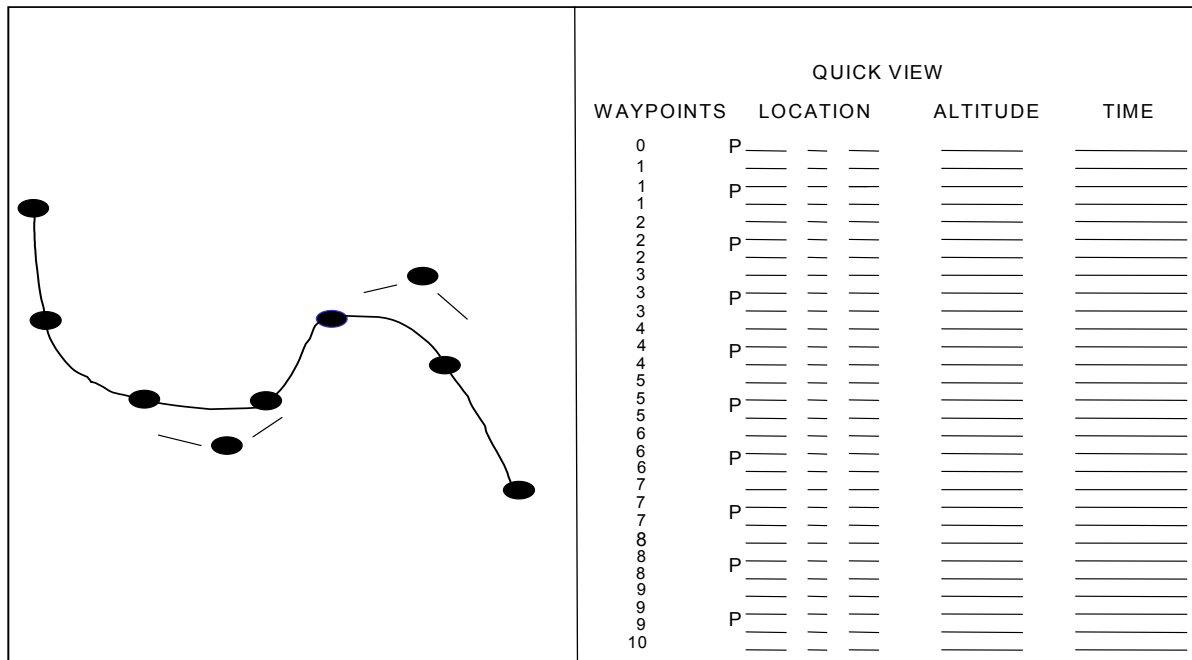

Figure 2-1. Quick View

2-66. The following vignette discusses Sentinel planning. It was prepared by the ADO from the 1-44 ADA during a recent National Training Center rotation.

Sentinel Planning Vignette

During a rotation to the National Training Center, the 1st Brigade, 4th Infantry Division, staff was planning a brigade attack. The attack would take place in the central and northern corridors of the training area. A high ridge that provided good pop-up points for RW aircraft and clear delineation for the FW AAA separated the two corridors. We were conducting a joint heavy/light rotation with armor, mechanized infantry, and a light infantry battalion.

Upon receipt of the new mission, I generated a FRAGO to assist in the parallel planning process for my platoon leaders. Knowing that we would be fighting all three corridors, I had my Sentinel platoon leader and team sergeant develop a list of quality air defense positions. The positions were developed using the LOS analysis capability on the air and missile defense workstation. The Sentinel leadership had developed approximately 20 positions in each corridor. These positions or “check points” would be very helpful during the fight.

During the mission analysis, the S2 and I jointly determined the enemy air SITEMPs. I determined that we would receive the following air threat, targeting the maneuver formations (tanks, Bradleys), artillery, C2, and air defense systems.

4 to 6 FW sorties in the central corridor to disrupt (H hour–H+1.5)

2 to 4 RW sorties in the Brown-Debman Passes/central corridor to support initial enemy defensive positions (NAIs 2, 3, and 5) (H+2–H+3)

2 to 4 FW sorties in the central/northern corridors (H+2.5–H+3.5)

4 to 6 RW sorties in the central corridor in support of main defensive area (H+3.5–H+4.5)

During the mission analysis briefing, I received clear guidance from the 1st Brigade commander on air defense priorities. Armed with a clear understanding of the mission, the weather and terrain, brigade commander’s air defense priorities, and the enemy’s COAs, I felt very confident as I generated my second WARNO.

As the staff generated COA statements and supporting sketches, I began to formulate a plan that would support the operation. As we prepared for the war-gaming process, I notified the Sentinel platoon leader and team sergeant of the time and location, to ensure attendance. Two facts that we identified in the planning process were we would have to position a Sentinel forward to support the crossing of the LD/LC, and a SINCGARS Sentinel would have to be closely located to support the SINCGARS-based light task force. The initial Sentinel emplacement would trigger the subsequent bound of the following Sentinel. This bound would be critical because it would have to move through the Brown-Debman Passes and emplace to provide an air picture to the forward TF. The terrain limited the Sentinel’s 40± km range. Even in the desert environment, it was terrain-restricted and that is why the LOS analysis is so critical. The speed of the tracked vehicles moving over the desert terrain compared to the Sentinel’s two HMMWVs with towed loads caused the teams to use maximum convoy speed. The two COAs that we war gamed consisted of two TFs attacking abreast or TFs in column in the

central corridor and one light TF attacking in the northern corridor. The Sentinel team sergeant immediately began analyzing the potential positions for Sentinel emplacement that would best support the scheme of maneuver. We discussed where in the sequence of march the Sentinel should be and what type of force protection the brigade could support me with. As the battery commander, the Sentinel is only one aspect of your planning process. I decided on a piece of high ground 2 to 3 kilometers from the LD/LC for the initial Sentinel placement with the second EPLRS Sentinel ready for movement. The second Sentinel would move behind the lead TF and would be OPCON for movement to the lead TF until it hit its release point. Once the second EPLRS Sentinel was emplaced, the first EPLRS Sentinel would march order and move behind the trail TF through the Brown-Debman Passes and emplace. This Sentinel would be OPCON for movement to the trail TF. The command relationship helped ensure that the Sentinels moved as part of the brigade combat team/TF, increasing survivability. Once emplaced, the second EPLRS Sentinel would bound forward to its final position providing a digitized air picture overlooking the objective. The emplaced SINGARS Sentinel provided an air picture until H-1, and then moved with the light TF. It moved behind the TF and emplaced 3 to 5 kilometers behind their positions providing a SINGARS-digitized air picture.

During the war game, I addressed Sentinel locations and triggers and identified potential requirements for maintenance and/or logistical support (also captured this in the brigade base order). The Sentinel platoon leader and team sergeant attended the war gaming. Their attendance was critical because it ensured they understood the fight. Once the war gaming was complete, a WARNO with a synchronization matrix and decision support template was disseminated.

The COA decision brief to the brigade commander resulted in choosing COA 2: two TFs in column with the light TF in the northern corridor. The OPORD was disseminated and all GS assets arrived to attend the brigade rehearsal. The Sentinel platoon leader, team sergeant, and the Avenger platoon leader attended the rehearsal. We then reviewed the operation, specifically discussing triggers and contingency operations.

The battery rehearsal was conducted via FM. The brigade and battalion timelines and distances involved did not allow for a rock drill. The battery rehearsal format was captured in our SOP. It ensured the DS platoon leaders understood the GS scheme of maneuver; where the Sentinels and Avengers were going to be located; and what the triggers were for movement. After a successful battery rehearsal was conducted, we were prepared to conduct the mission.

TROOP-LEADING PROCEDURES

2-67. Troop-leading procedures are designed to focus the Sentinel platoon leader's effort, given the time available, on preparations for the mission. At the Sentinel team level, many actions are based on SOPs and standard unit drills. These include evacuation of wounded soldiers, rearming and resupply procedures, and Sentinel team individual soldier responsibilities. This allows the Sentinel teams to operate quickly and efficiently without constant guidance from the section sergeants.

2-68. Troop-leading procedures are the basis of the dynamic process by which units develop plans and orders at every level of leadership. This process, although discussed here with the eight steps in traditional order, is not rigid and the steps are not necessarily sequential. The tasks involved in some steps (such as initiate movement, issue the digital warning order, and conduct digital reconnaissance) may recur several times during the process. Although listed as the last step, activities associated with supervising and refining the plan and other preparations occur throughout troop leading.

2-69. Troop-leading procedures begin when the platoon leader receives the first indication of an upcoming operation (often by warning order from higher headquarters) and continue throughout the planning, preparation, and execution phases of the mission. The platoon leader maximizes the available planning time by starting as soon as the first bit of information becomes available. He normally uses one-third of the available time to plan, prepare, and issue the order. His section sergeants then have the remaining two-thirds of the time available to conduct their own troop-leading procedures. This time allocation is known as the “one-third/two-thirds” rule of planning and preparation. The following discussion provides a step-by-step overview of troop-leading procedures.

STEP 1—RECEIVE AND ANALYZE THE MISSION

2-70. The platoon leader receives his orders in a digital, oral, or written form in an operation order, FRAGO, or warning order. Upon receipt of the order, he begins analyzing the mission using the factors of mission, enemy, terrain (and weather), troops, time available, and civil considerations.

STEP 2—ISSUE A WARNING ORDER

2-71. After the platoon leader has analyzed his orders and worked out his mission and related tasks, he must quickly pass this information to his section sergeants either by digital or hard copy. This is accomplished through the warning order. As a minimum, the following information must be included:

- Elements and individuals to whom the warning order applies.
- Enemy situation as stated in the task force order.
- The time and nature of the operation.
- The earliest time of movement.
- Coordinating instructions, including an initial time line.
- The time and place the OPORD will be issued.

STEP 3—MAKE A TENTATIVE PLAN

2-72. Based on results of his mission analysis, the platoon leader develops possible courses of action that address all specified, implied, and essential tasks, and sufficiently support the supported force.

STEP 4—INITIATE MOVEMENT

2-73. After issuing a warning order and making a tentative plan, the platoon leader initiates any required movement. Movement includes

positioning teams at preselected coordinates to broadcast EW, linking up with force protection assets, pre-positioning with supported assets, and dispatching an advance party to a new assembly area. Proper positioning and timely linkups are essential to early warning integration.

STEP 5— CONDUCT RECONNAISSANCE

2-74. This step of the troop-leading procedures allows the platoon leader to confirm the validity of his tentative plan and to refine the plan. When possible, the platoon leader should conduct the reconnaissance with his section sergeants. This will allow them to see the terrain and develop a better visualization of the projected plan. At a minimum, the platoon leader conducts this step as a detailed map reconnaissance. Reconnaissance includes evaluation of the initial march route to the LD, identified movement corridors, initial positions, and all possible subsequent positions.

2-75. If section sergeants cannot personally conduct onsite reconnaissance, they should make the most efficient use of available time by tasking their teams to accomplish specific reconnaissance requirements. An example of this is tasking a Sentinel team to reconnoiter and ascertain time routes to the SP. The section sergeant must conduct the reconnaissance with an open mind; not everything he sees will match the Sentinel platoon leader's tentative plan. He must be flexible enough to change and competent enough to work out new plans rapidly.

STEP 6—COMPLETE THE PLAN

2-76. The platoon leader refines his plan based on the results of the reconnaissance. He then completes the plan using these results and any new information from the supported force, the higher headquarters staff, and the members of his sections. He should keep the plan as simple as possible, at the same time ensuring that it effectively supports the commander's intent.

STEP 7—ISSUE THE ORDER

2-77. The platoon leader issues the order to all section sergeants. Revised operation graphics are distributed to teams prior to issuing the order. Each section sergeant ensures that each team overlay matches his overlay. To use his time most efficiently, the platoon leader should use a walk-through rehearsal as part of his briefing of paragraph 3 of the order.

2-78. If the platoon leader can issue the order from a favorable vantage point, he or the section sergeants can physically indicate the ground over which the teams will maneuver. If a vantage point is not available, he can use a terrain cloth, sand table, or a map as a reference. The platoon leader or section sergeants should have a briefing kit available to build a model of the area of operations. Items in the kit might include the following:

- Nylon rope and nails or spikes.
- Preconstructed Plexiglas squares for units and equipment (blue for friendly elements, red for enemy forces).
- "Micro" armor vehicles or other models.
- Pens and markers.

- Stakes.
- Engineer tape.
- Operational symbol cutouts.
- Dry eraser board.

2-79. The order is issued in the five-paragraph OPORD format. To ensure complete understanding of the operation, leaders should end the order with a backbrief of key points by their team chiefs.

STEP 8—SUPERVISE AND REFINE

2-80. Flexibility is the key to effective operations. The platoon or section sergeant must be able to refine his plan whenever new information becomes available. If they adjust the plan, they must inform the teams and supervise implementation of the changes. Once the operation has begun, the section sergeants must be able to direct their sections in response to new situations.

BACKBRIEFS, REHEARSALS, AND INSPECTIONS

2-81. Backbriefs, rehearsals, and inspections are essential elements of the supervision process as the team prepares for the mission. The following paragraphs discuss these procedures in detail.

BACKBRIEFS

2-82. The backbrief is, in effect, a reverse briefing process. Those who receive an OPORD confirm their understanding of it by repeating and explaining details of the operation for their section sergeants. In a Sentinel section, the section sergeants should conduct backbriefs after their teams have received the OPORD, but before the team rehearsal begins.

REHEARSALS

2-83. A rehearsal is the act or process of practicing an action in preparation for the actual performance of that action. Rehearsing key combat actions allows the Sentinel teams to become familiar with the operation and to translate the relatively dry recitation of the tactical plan into visual impression. This visual impression assists the Sentinel teams in orienting themselves to both their environment and to other units during the execution of the operation. Moreover, the repetition of combat tasks during the rehearsal leaves a lasting mental picture of the sequence of key actions within the operation. Rehearsals also provide a forum to analyze the tactical plan, to ascertain its feasibility, common sense, and the adequacy of its command and control measures before it is too late. To be effectively and efficiently employed in combat, rehearsals need to become habitual in training. The Sentinel platoon should routinely train and practice a variety of rehearsal techniques. The local SOP should identify appropriate rehearsal techniques and standards for execution. Time is probably the most precious resource available to the Sentinel teams. Rehearsals take time. The time required for rehearsal varies with the complexity of the task to be rehearsed, the type of rehearsal, and the level of participation. For this reason, the emphasis on rehearsals should be at the lowest level possible, using the most

thorough technique possible given the time available. The Sentinel teams use well-planned, efficiently run rehearsals to accomplish the following:

- Reinforce training and increase proficiency in critical tasks.
- Reveal weaknesses or problems in the plan.
- Synchronize the actions of subordinate elements.
- Improve each soldier's understanding of the concept of the operation.

2-84. The section sergeants can choose among several techniques in conducting rehearsals, which should follow the crawl-walk-run training methodology to prepare the sections for increasingly difficult conditions. The following discussion examines the available rehearsal techniques.

Full-Dress Rehearsal

2-85. A full-dress rehearsal is the most effective form of rehearsal. However, it consumes the most time and resources. This technique may involve up to every Sentinel team soldier taking part in the operation. If possible, the Sentinel platoon conducts the full-dress rehearsal under the conditions (weather, time of day, terrain) expected to be encountered during the actual operation. In defensive operations, the platoon can conduct a full-dress rehearsal over the actual terrain. In an offensive operation, the platoon conducts the rehearsal on any available terrain that closely matches the terrain of the zone of operations. These rehearsals are the most productive type of rehearsal; however, they are also the most resource- and time-intensive.

Map Rehearsal

2-86. A map rehearsal has two variations. The most common is to use a large-scale (1:25,000) map and operations overlay, laid horizontally with Sentinel team chiefs seated around it. This technique is especially suited for inclement weather or at night, since the rehearsal can take place in a tent or building. A marker (such as a cardboard cutout or micro armor) is used to track each radar as it moves and each key event as it happens. Each team chief is responsible for placing and moving his own markers. Another option is to move to a location that allows a view of the area of operations, with each team chief following the rehearsal using his own map and operations overlay. This technique has the added advantage of terrain familiarization for the team chiefs, but it has the disadvantage of allowing potential misinterpretations and terrain management conflicts. The section sergeants also use the map and overlay to guide themselves as they backbrief their role in the operation. If necessary, they can use a sketch map.

Radio Rehearsal

2-87. A radio rehearsal is less time- and resource-intensive than the map rehearsal, but is not as desirable because Sentinel team chiefs do not share information face-to-face. The battalion, battery, or maneuver brigade can conduct a radio rehearsal anytime, a technique used extensively by fire support units. To conduct a radio rehearsal, the Sentinel platoon leader and his team chiefs transmit an interactive verbal execution of critical portions of the operation over the FM radio net. For this technique to be effective, every

Sentinel platoon member must have operable communications, a copy of the appropriate OPOD, and all appropriate overlays. The supported unit rehearses only the essential/critical phases of the operation. Prolonged FM radio communications even when conducted with secure radios may offer the enemy vital intelligence and targeting information on the operation. The Sentinel platoon leader should use this method only as a last resort. In some cases, radio rehearsals are essential to verify the communications system will work. If you intend to execute the plan digitally, use a radio rehearsal to test the system.

Sand Table

2-88. This technique employs a small-scale table or model that depicts graphic control measures and important terrain features for reference and orientation. Participants walk or move micro armor around the table or model to practice the actions of their own vehicles in relation to other members of the section.

Mounted Rehearsal

2-89. A mounted rehearsal is also time-consuming. However, if time permits, a mounted rehearsal presents a way for every soldier in the team to gain a clear understanding of the plan and the concept of the operation. It allows team chiefs to maneuver their vehicles and rehearse critical events.

INSPECTIONS

2-90. Precombat inspections allow section sergeants to check the teams' operational readiness. The intent is to ensure that soldiers and vehicles are fully prepared to execute the upcoming mission. The section sergeants make sure the entire chain of command conducts precombat checks and per SOP. The following are examples of procedures that can be covered in PCCs and PCIs:

- Perform before-operation maintenance checks and report or repair deficiencies.
- Perform prepare-to-fire checks for all weapons and report or repair deficiencies. Make sure weapons are boresighted and all sights are calibrated. Machine guns should be test-fired, if possible.
- Upload vehicles per SOP.
- Conduct resupply of rations, water, fuel, oil, weapons, ammunition, pyrotechnics, first aid kits, and equipment batteries (for such items as flashlights, night-vision devices, mine detectors, and NBC alarms).
- Make radio checks, when possible.
- Make sure team members are in the correct uniform and mission-oriented protective posture level.

Chapter 3

Sentinel Coverage in Offensive and Defensive Operations

This chapter discusses Sentinel employment in support of both offensive and defensive operations. In order to provide effective support to maneuver forces conducting offensive and defensive operations, air and missile defense leaders must clearly understand all aspects of the offensive and defensive fight, and ensure Sentinel assets are properly integrated into the supported force's scheme of maneuver.

OFFENSIVE OPERATIONS

3-1. The offense is the primary means of gaining and maintaining the initiative on the battlefield. Through constant offensive pressure on the enemy, the commander is able to force the enemy to conform to his intent and retain his own freedom of maneuver. Based on the dynamics and tempo of offensive operations, the Sentinel platoon will normally attach two Sentinel teams (one section) to the divisional AMD firing batteries in support of the brigade combat team. This section describes how the digitized Sentinel teams integrate and operate with the divisional AMD battery during offensive operations.

SENTINEL EMPLOYMENT IN THE OFFENSE

3-2. Proper employment of Sentinel teams during offensive operations requires considerable planning and coordination. Factors include the form of the offensive operation being conducted, forms of maneuver, movement formations, reconnaissance and surveillance (R&S) plans, and all products of the intelligence preparation of the battlefield (IPB) process. This section describes Sentinel section employment based on the four forms of offensive operations (movement to contact, attack, exploitation, and pursuit).

MOVEMENT TO CONTACT

3-3. A movement to contact is conducted when the enemy situation in the objective area is vague and friendly forces are attempting to gain or reestablish contact with the enemy. It is used to develop the situation early to provide an advantage before decisive engagement. A movement to contact is characterized by decentralized control and the rapid commitment of forces from the march. Upon contact with the enemy, the operation ends in an attack, a defense, a withdrawal, or a bypass.

3-4. Based on the tempo, depth, and uncertainty of movements to contact, Sentinel teams will normally move using bounding overwatch techniques in order to ensure adequate early warning and coverage throughout the depth of the battlefield. The divisional AMD battery commander (with guidance from the AMD battalion S3 and BCT S3) will identify a number of positions

throughout the assigned area of operations (AO) (preferably no more than 20 kilometers apart) which best supports R&S planning and the scheme of maneuver. These positions must be located on suitable terrain allowing Sentinels to focus on air avenues of approach (AAAs), NAIs, and pop-up-points (PUPs) identified during the IPB process.

3-5. Dependent upon terrain and the overall enemy situation, an initial Sentinel team can either be employed forward of the line of departure (LD) with reconnaissance elements or remain in a position behind the LD prior to the start of the mission. As Sentinel Team One provides reconnaissance and early warning for the BCT and divisional AMD battery, Sentinel Team Two moves forward to the previously designated location identified by the battery commander during the planning process. Once emplaced and operational, Sentinel Team One march orders and moves forward to its previously designated location. This process will continue until the movement to contact is complete.

ATTACK

3-6. An attack is an offensive operation characterized by coordinated movement supported by fire. The principal attack options include hasty attack, deliberate attack, raid, feint, and demonstration. Sentinel team employment may or may not vary based on the attack option being executed.

Hasty Attack

3-7. A hasty attack is conducted to gain or maintain the initiative and is usually conducted following a movement to contact. To maintain momentum, a hasty attack is conducted with the resources immediately available.

3-8. Since the hasty attack is usually the culmination of a movement to contact, Sentinel team employment will normally only require refinement. Commanders need to reevaluate the Sentinel team employment plan upon the execution of a hasty attack to ensure that previously designated positions can adequately support the operation. Slight modifications may be required due to the uncertainty of enemy activity during the initial planning process. Enemy forces bypassed by the BCT will also require special consideration as they pose a particular threat to Sentinel teams moving to forward positions.

Deliberate Attack

3-9. A deliberate attack is a fully synchronized operation conducted when the enemy situation is known. It is characterized by the planned employment of firepower and maneuver to close with and destroy the enemy. It involves a detailed reconnaissance effort, evaluation of all available intelligence and relative combat strength, analysis of various courses of action, and other factors affecting the situation.

3-10. Sentinel team employment during a deliberate attack is similar to employment during a movement to contact. The divisional AMD battery commander (with guidance from the AMD battalion S3 and BCT S3) identifies positions throughout the assigned AO that support R&S planning and the scheme of maneuver. Positions are identified on suitable terrain that

allows Sentinels to focus on AAAs, NAIs, and PUPs identified during the IPB process.

3-11. Dependent on the depth of the battlefield during a deliberate attack, the divisional AMD battery commander may choose not to bound Sentinel teams to cover the movement forward of the BCT. However, planning for the movement of Sentinels to cover the BCT upon seizing the objective is a must. This involves a detailed analysis of enemy counterattack options and probable counterattack AAAs, NAIs, and PUPs. Proper planning for enemy counterattacks will require that Sentinel Team One move forward with the BCT during the attack in order to be emplaced and operational in time to be of any significant value during the counterattack. Once the forward Sentinel team is emplaced and operational, Sentinel Team Two will move forward to support Sentinel Team One, and if required, position to support exploitation and pursuit missions. See Figure 3-1.

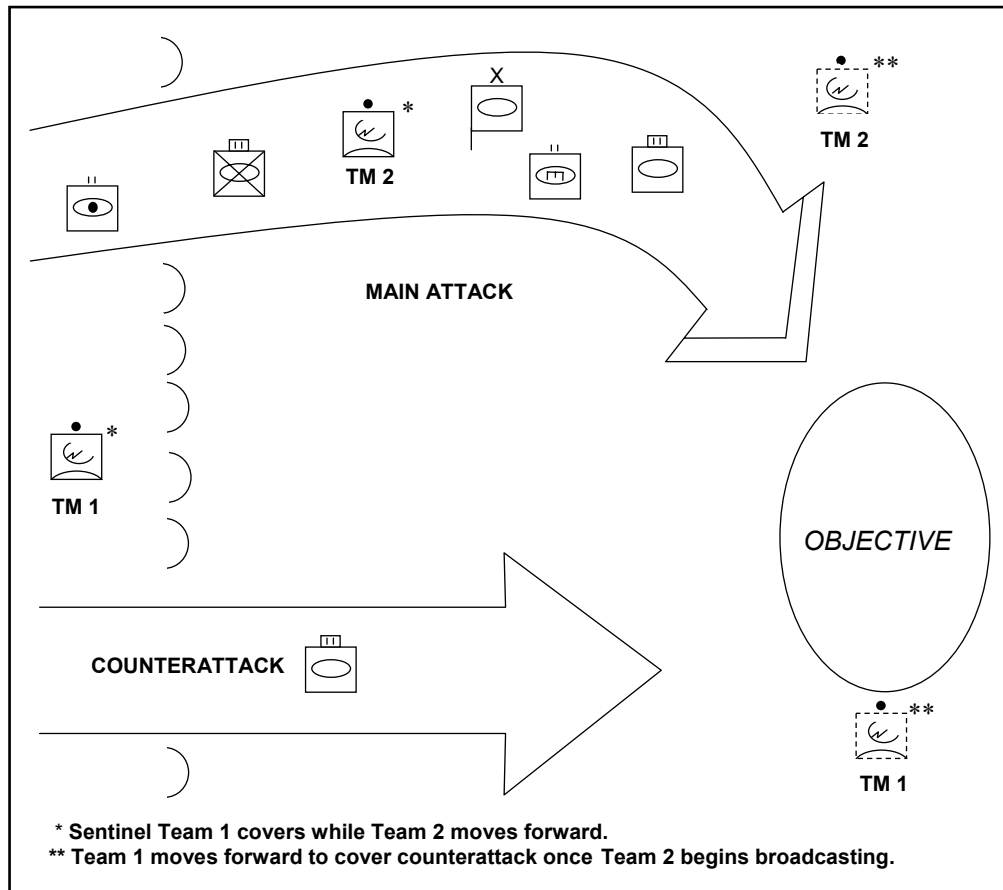

Figure 3-1. Deliberate Attack

Raid

3-12. A raid is usually a "small scale" offensive tactical operation involving swift movement into hostile territory and ending with a planned withdrawal.

Raids are normally short in both distance and duration and limited in support and logistics. Raids are conducted to—

- Capture prisoners, installations, or enemy materiel.
- Destroy enemy materiel or installations.
- Obtain specific information (location, disposition, strength, operating scheme) on threat forces.
- Deceive or harass threat forces.
- Liberate friendly, captured personnel.

3-13. Based on the characteristics of a raid, Sentinel teams are rarely employed as far forward as the objective. The tempo of a raid dictates that only those systems capable of providing overwhelming firepower with the ability to rapidly ingress and egress move forward to the objective. Sentinel teams in support of a raid are initially positioned along the FEBA or FLOT. Dependent on the depth of the operation, the battery commander, in conjunction with the AMD battalion and BCT S3, determines if any further movement is required to ensure adequate coverage and early warning for the maneuver force. If the decision is made to move a Sentinel forward, positions are identified far enough forward to provide visibility 20 kilometers beyond the objective, but not too close to the enemy FLOT as to put the Sentinel at excessive risk. METT-TC will be the deciding factor as to how far forward Sentinels will actually be placed.

3-14. If a Sentinel team is placed forward during a raid, Sentinel team planning must include both coverage of the force moving forward, and coverage during the withdrawal. During the movement forward, one Sentinel team emplaces along the FLOT while the other team moves forward with the BCT. Once in position, the forward team provides the necessary coverage of the final stages of the raid. Upon completion of the raid and initiation of the withdrawal, the forward Sentinel team march orders and prepares to fall in with the withdrawing forces. The rear Sentinel team assumes coverage of the AO for the remainder of the operation. The battery commander must synchronize the withdrawal of the forward Sentinel team with the BCT S3 ensuring linkup with the returning maneuver forces. The section sergeants should ensure a smooth linkup occurs between the Sentinel team and the returning forces.

Feint

3-15. A feint is a limited objective attack. It is a show of force intended to deceive the enemy and draw attention away from the main attack. A feint must be conducted with sufficient strength and composition to cause the desired enemy reaction. Feints must appear real; therefore, some contact with the enemy is required. Brigades execute feints as part of a corps or division attack.

3-16. Since a feint replicates a legitimate deliberate attack, it is likely that there will be an air threat response by enemy forces. Therefore, Sentinel teams are employed during a feint just as they are during a deliberate attack. In addition, active radar emissions during a feint add to the deception objective desired by the corps or division commander. Specific attention

during Sentinel employment planning must be given to ensure that Sentinel teams are not overcommitted during a feint since it is a limited objective operation.

Demonstration

3-17. A demonstration is an attack or show of force in an area where a decision is not being sought. It is conducted with the intention of deceiving the enemy; however, no contact with enemy forces is made.

3-18. Sentinel teams are employed and active during demonstrations in order to meet the commander's deception intent. Sentinel teams are usually not employed forward of the FEBA during a demonstration, but commanders must ensure positioning of Sentinels provides adequate coverage of AAAs, NAIs, and PUPs.

EXPLOITATION

3-19. Exploitation is an offensive operation that follows a successful attack to take advantage of weakened or collapsed enemy defenses. Its purpose is to prevent reconstitution of enemy defenses, prevent enemy withdrawal, secure deep objectives, and destroy command and control facilities and enemy forces. Exploitation maintains relentless pressure on the enemy, bypassing small pockets of resistance, and focusing on the final objective.

3-20. The battery commander's initial planning drives Sentinel team employment during the exploitation. Since exploitation opportunities are difficult to anticipate, battery commanders must consider the possibility of exploitation operations during the planning process and visualize how the operation will take place. The battery commander's air IPB will not only focus on the close fight, but also look at the entire depth of the battlefield. Possible Sentinel positions are identified initially and refined as necessary during execution of the exploitation. Based on the likelihood that the enemy will employ rotary wing aircraft to cover withdrawing forces, Sentinels must be in position early to provide sufficient early warning for the exploiting force. Special consideration needs to be given to force protection during the exploitation due to the likely number of bypassed enemy forces by the exploitation force.

PURSUIT

3-21. The pursuit normally follows a successful exploitation. The primary function of the pursuit is to complete the destruction of the enemy forces. Unlike the exploitation, which is focused more on destroying the enemy support system, the pursuit is focused on the destruction of the main force. The pursuit is ordered when the enemy can no longer maintain its position and tries to escape. Brigades conduct pursuit operations as part of a corps or division pursuit, functioning as either the direct pressure or encircling force.

3-22. Sentinel team employment during a pursuit is conducted in the same manner as in the exploitation. Prior planning and the continuous updating of the air IPB by the battery commander provide the groundwork for Sentinel team employment in support of the pursuit.

DEFENSIVE OPERATIONS

3-23. Defensive operations defeat an enemy attack, buy time, economize forces, or develop conditions favorable for offensive operations. Defensive operations alone normally cannot achieve a decision. Their purpose is to create conditions for a counteroffensive that regains the initiative. The Sentinel platoon supports defensive operations by providing air and missile defense early warning to the force throughout the planning, preparation, and execution process. This section describes how Sentinel teams integrate and operate with the divisional AMD battalion and or battery during both area and mobile defensive operations.

SENTINEL SUPPORT OF DEFENSIVE OPERATIONS

3-24. Proper employment of Sentinel teams during defensive operations requires considerable planning and coordination. Due to the sheer complexity of defensive operations, each and every defense may dictate a different Sentinel employment method. Therefore, when planning Sentinel support of the defense, leaders must consider all the factors of METT-TC, to include the size of the defending force and the type of defense to be conducted.

3-25. Defensive operations can be conducted by virtually any size of force, but are normally conducted at the division or corps level. In this case, brigades and battalions execute defensive operations as part of the larger force. When brigade or smaller size forces conduct defensive operations, AMD commanders normally attach a Sentinel section to the AMD element in support of that defending force to provide required early warning. However, since defensive operations are normally conducted at the division or corps level, the decision on how to employ Sentinel is much more complex.

3-26. During division and corps defensive operations, brigade and battalion size elements will be required to execute a myriad of mobile tasks. Brigade or battalion size forces conduct counterreconnaissance fights, spoiling attacks, act as reserves, and possibly conduct counterattacks, all in support of the overall defensive mission. Based on the number and size of maneuvering elements in the defense, along with the size of the AO, AMD battalion commanders must develop Sentinel employment plans that support mobility, provide flexibility, and allow for overlapping and redundant early warning to ensure adequate coverage of the supported force. Maintaining the entire Sentinel platoon in general support to the division normally ensures the greatest employment flexibility and helps to ensure better overlapping and redundant coverage. Battalion commanders can easily move Sentinel teams throughout the division's AO as required, and ensure sufficient coverage of AAAs when Sentinels are employed in a GS role. However, there may be increased risk to the mobility and survivability of Sentinel teams when employed in this manner. Sentinel teams employed forward during the preparation phase and counterreconnaissance fight must be prepared to conduct a rearward passage of lines as the enemy force approaches the MBA. Due to the complex nature of this task and increased risk of fratricide, it is usually easier to attach these Sentinel teams to AMD elements supporting the counterreconnaissance force. This way, the receiving AMD elements can ensure linkups and passages are properly coordinated and executed.

3-27. There are three basic types of defensive operations: area, mobile, and retrograde. Although each type of defensive operation includes elements of the other two, all three types differ significantly in concept, posing unique challenges when planning Sentinel employment.

AREA DEFENSE

3-28. An area defense is a type of defense operation that concentrates on denying an enemy force access to designated terrain for a specific amount of time rather than destroying the enemy outright. Area defenses are normally conducted by corps, divisions, or separate brigades. Subordinate unit echelons defend within their assigned area of operations as part of a larger echelon operation.

Planning

3-29. In planning for the area defense, the commander decides where to concentrate efforts and take risks, allowing him to fully synchronize the effects of combat and supporting systems and apply overwhelming combat power at decisive times to destroy the enemy. Commanders organize an area defense in depth or forward.

3-30. A defense in depth is usually the preferred organization since it provides the commander flexibility and the ability to absorb the enemy's momentum through a series of mutually supporting positions. However, based on constraints imposed by mission or terrain, the commander may be forced to conduct a forward defense where forces strive to deny penetration and destroy the enemy through violent counterattacks.

3-31. The AMD officer likewise determines where to concentrate Sentinel coverage and where to assume risk in order to provide the best air threat early warning to the supported force and shape the battlefield for decisive victory. AMD officers plan Sentinel employment with emphasis on synchronizing coverage and movements with the supported force commander's concept, scheme of maneuver, and surveillance plans. Sentinels are placed no more than 60 kilometers apart (terrain dependent), with a minimum distance of 5 kilometers between Sentinels and high-power RF sources. Sentinel employment plans are also coordinated and synchronized with the supporting divisional AMD forces to ensure that all AMD weapon systems are captured in the Sentinel broadcast zones. Since both Sentinels and AMD weapon systems will be required to move at different times during any operation, detailed coordination must be made to ensure these links are maintained. AMD officers ensure that Sentinel employment plans can adequately support AMD weapon systems in both primary and alternate positions and when moving. When Sentinels are required to move, AMD systems linked to those Sentinels are transferred to alternate Sentinels so that there is no significant break in broadcast links and early warning. The key to successful Sentinel and weapon system hand-offs on the battlefield the level of training of order dissemination, and the quality of the rehearsal.

3-32. When conducting a defense in depth, AMD officers select Sentinel positions that are mutually supporting and allow for continuous coverage

during individual Sentinel displacement. As enemy forces and forward Sentinels displace, the AMD officer ensures rear Sentinels are properly positioned to cover AAAs and PUPs dropped by the forward Sentinel. Since a defense in depth requires frequent Sentinel movement, the number of Sentinels broadcasting at one time will be reduced. Therefore, AMD officers must prioritize Sentinel coverage and possibly assume risk with reduced coverage on less likely AAAs. When conducting a forward defense, AMD officers also identify Sentinel positions that are mutually supportive, but since the depth of a forward defense does not require frequent Sentinel displacement, they can usually provide Sentinel coverage of most, if not all, possible AAAs.

Preparation

3-33. Since a unit normally transits to the defense following offensive operations, significant preparation is required to properly execute the defense. Counterreconnaissance forces are employed to deny enemy observation of activities, sustaining forces rearm and refuel weapon systems and pre-position ammunition, and engineers build position obstacles and engagement areas. Defending forces are particularly vulnerable to aerial surveillance and attack during the preparation phase. Therefore, Sentinel teams must be in position and broadcasting early warning to the force as early as possible. It is vitally important that Sentinel emplacement is tied to the division or brigade combat team event matrix, so that it will always support the concept of the operation.

3-34. ADOs employ forward Sentinel teams using scouts and counterreconnaissance forces to provide security as they move to positions outside of the MBA. The ADO identifies Sentinel positions far enough forward of the MBA to allow radar coverage at least ten kilometers beyond the counterreconnaissance force. A minimum of two Sentinel teams should be employed forward to cover division level counterreconnaissance efforts. Sentinel teams also employ in the vicinity of the MBA to cover possible flanking AAAs where threat air platforms can ingress and attack preparation efforts. All Sentinel positions, forward or in the MBA, must be located on suitable terrain, allowing Sentinels to focus on AAAs, NAIs, and PUPs identified during the IPB process. ADOs must apply METT-TC, because history has shown that AMD forces, when moved forward with counterreconnaissance in corps battle simulations, suffer high levels of attrition.

3-35. As the enemy main attack is initiated, forward-deployed Sentinels withdraw to the MBA. As forward Sentinel teams march order and prepare to fall in with the withdrawing counterreconnaissance forces, rear Sentinel teams maintain coverage of the AO. The ADO must synchronize the withdrawal of the forward Sentinel teams with the division GS/BCT S3, ensuring linkup with the returning maneuver forces. The Sentinel team chief coordinates directly with linkup forces and coordinates linkup points and any other specific requirements to avoid confusion or possible fratricide.

Execution

3-36. Commanders execute an area defense by combining static elements to control, stop, or canalize the attacking force and dynamic elements to strike and defeat the attacker. Defending forces fight mainly from prepared positions to concentrate combat power and deny enemy forces the ability to flank or break through the MBA. Mobile forces are employed in the defense to cover gaps, reinforce positions, and counterattack the enemy from unanticipated directions.

3-37. During the execution of an area defense, ADOs rely primarily on Sentinels that were not employed forward of the MBA during the preparation phase to provide early warning to the force. Sentinels returning with the counterreconnaissance force are directed to positions supportive of Sentinels already employed in the MBA, or to cover dead space in existing coverage. ADOs consider the depth of planned counterattacks and determine whether or not positioning of Sentinels in the MBA can adequately cover the attacking force. If positioned Sentinels cannot adequately cover a counterattack, the ADO may choose to hold a Sentinel in reserve so that it is available to move forward when required. ADOs also consider the possible requirement to support retrograde operations. See Figure 3-2.

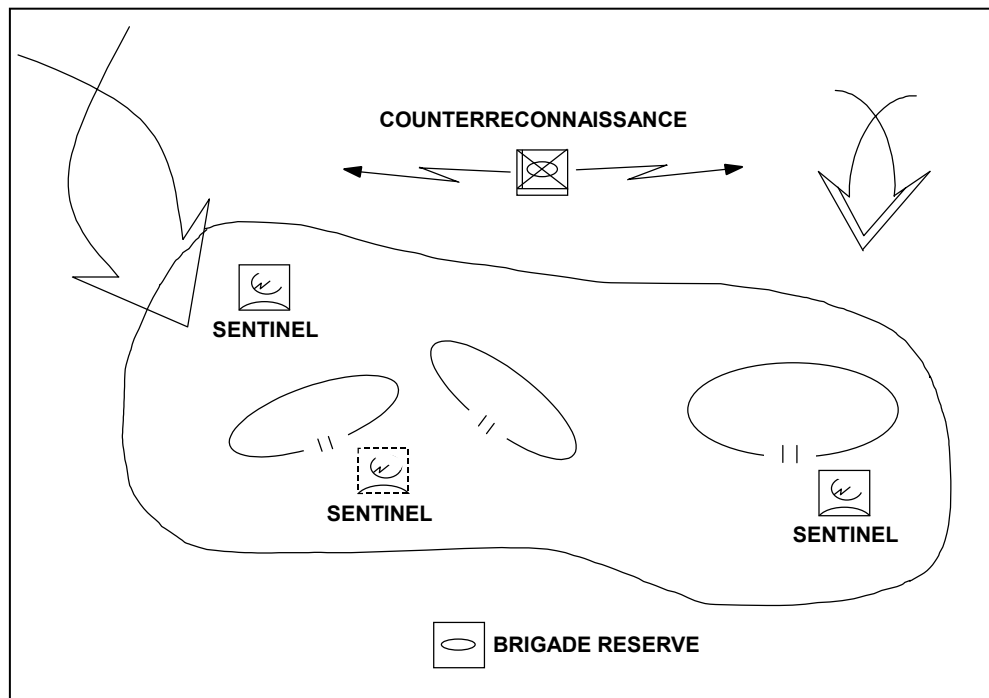

Figure 3-2. Brigade Area Defense

MOBILE DEFENSE

3-38. A mobile defense is a type of defense operation that concentrates on the destruction or defeat of enemy forces through a decisive attack by a striking force. It focuses on destroying the attacking force by permitting the enemy to advance into a position that exposes him to counterattack and

envelopment. Commanders normally choose to use a mobile defense when defending against an enemy with greater combat power but less mobility, or when the terrain is open with no well-defined avenues of approach. Based on the complexity of a mobile defense and the requirement to execute multiple simultaneous engagements, elements smaller than a corps do not normally conduct a mobile defense. Divisions and brigades participate as part of the mobile defense by conducting either area defensive operations as the fixing force, or attack operations as the striking force.

3-39. The commander plans the positioning of both the fixing and striking force taking into consideration the size of the enemy force and the depth to which the commander wishes to strike the attacker. He then organizes his forces allocating the bulk of available combat power to the striking force.

3-40. Because the overall mobile defense is normally conducted at the corps level, ADOs at division level and below plan Sentinel employment based on the mission assigned to the supported unit either in support of an attacking force or a force conducting an area defense. ADOs plan Sentinel employment with emphasis on synchronizing coverage and movement with the supported force commander's concept, scheme of maneuver, and surveillance plans. Sentinel employment plans are also coordinated and synchronized with the supporting divisional AMD forces to ensure that all AMD weapon systems are captured in the Sentinel broadcast zones.

3-41. Although coordinating Sentinel coverage with adjacent and higher echelon Sentinels is required in all offensive and defensive operations, initial coordination of Sentinel positioning is essential when participating in a mobile defense. Sentinels supporting the striking force will normally employ to cover possible flanking AAAs, NAIs, and PUPs, and cover routes used by the striking force. However, they will normally be forced to rely on an air picture generated by Sentinels covering the fixing force for sufficient early warning during the actual attack. Therefore, coordination must be made between ADOs on Sentinel positioning and broadcast frequencies to ensure continuous coverage is maintained.

RETROGRADE OPERATIONS

3-42. Retrograde is a type of defensive operation that involves organized movement away from the enemy. The operation may either be forced by the enemy or voluntarily executed by the commander. There are in essence three different forms of retrograde that can be conducted by a commander: *delay*, *withdrawal*, and *retirement*. A delay is a form of retrograde in which a force under pressure trades space for time by slowing the enemy's momentum and inflicting maximum damage on the enemy without becoming decisively engaged. A withdrawal is a planned operation in which a force in contact disengages from an enemy force. A retirement is conducted when a force not in contact with the enemy moves away from the enemy.

3-43. In each form of retrograde, friendly forces are either in contact with enemy forces, or are likely to be confronted by the enemy in some manner. Enemy forces will likely attempt to exploit perceived successes during delays and withdrawals by committing threat aircraft. During retirements, the enemy may attempt to interdict the retiring element with air strikes or air

assaults. Therefore, regardless of the form of retrograde being conducted, it is essential that Sentinel teams be well integrated with the operation.

3-44. ADOs plan Sentinel employment during retrograde operations with emphasis on providing coverage as far as possible without leaving teams in positions where they are vulnerable to enemy direct fire. During all types of retrograde operations, ADOs should plan to employ Sentinel teams in echelon with the most forward team located in the vicinity of second echelon friendly forces. This allows Sentinels to provide sufficient coverage of forward forces, but still provides the forward-deployed team with sufficient time to march order and displace once first echelon forces disengage or begin their withdrawal. As the forward Sentinel march orders, AMD assets are linked to other rear Sentinels that assume coverage of the force. See Figure 3-3.

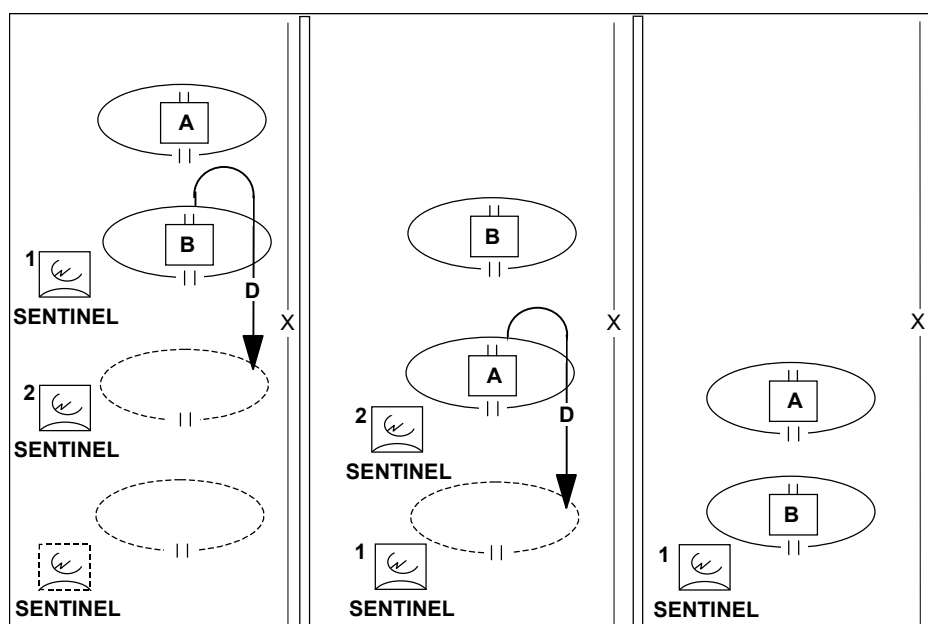

Figure 3-3. Delay Operation

SUPPORT OF LIGHT AND SPECIAL OPERATIONS

3-45. Light and special operations present some unique challenges to AMD leaders when employing Sentinel teams on the battlefield. Although Sentinel planning considerations in light and special operations remain consistent with those used in heavy operations, battlespace construct and missions assigned often require AMD leaders to employ Sentinel differently than they would during heavy operations.

BATTLESPACE CONSTRUCT

3-46. Light and special operations are unique in the fact that the battlespace is often much more condensed than the battlespace in heavy operations. Although the condensed terrain minimizes the requirement to move Sentinel teams to provide continuous support to attacking forces, this same terrain minimizes the options available to commanders for employing

radars. This condensed battlespace limits the planner's ability to maximize the Sentinel's capabilities, and reduces the availability of employment positions within the assigned AO. Furthermore, light and special operations are often conducted in areas of wooded terrain, urban environments, and mountainous areas that further limit employment options due to trafficability and radar masking.

3-47. When planning Sentinel employment in support of light and special operations, battery commanders must consider the depth of the battlespace ensuring that Sentinel teams can adequately support the entire force while maintaining coverage of identified threat AAAs. Commanders must also consider the distance between employed Sentinel teams. When Sentinels are positioned within five kilometers of each other, one must counterrotate when both are operational. Terrain masking must also be considered not only from the perspective of acquiring an air picture, but also from the perspective of broadcasting the air picture to the supported fire units.

3-48. When employing Sentinel teams in restrictive terrain, the number one concern for the battery commander from a planning perspective is the ability to provide the force with a continuous air picture. Sentinel teams must be positioned in clearings, or far enough away from built-up areas so that radars are not masked. Oftentimes, these positions will be away from the bulk of the supported force, so commanders must make special arrangements for the force protection of these assets.

SUPPORT OF DIVERSE MISSIONS

3-49. Light and special divisions are likely to conduct or participate in a variety of missions. These missions provide particular challenges to leaders planning Sentinel employment. Some of these missions include supporting airborne and air assault, mountain, MOUT, and stability and support operations.

Airborne and Air Assault Operations

3-50. Airborne and air assault missions provide their own unique set of challenges to the AMD planner, and require special consideration when planning Sentinel team employment. These missions are executed over vast distances, usually in non-secure areas, and are greatly dependent on airlift availability. Due to the fact that there is limited availability of lift assets, AMD leaders must be prepared to operate with reduced radar coverage for extended periods of time until additional Sentinels are brought in. When planning Sentinel coverage of these operations, leaders must employ the initial Sentinel to cover the most likely enemy air avenue of approach. When a single most likely avenue of approach cannot be identified, leaders should employ the initial Sentinel in a position that provides the best overall area surveillance of the battlespace rather than oriented on a specific avenue. Likewise, when a most likely avenue has been identified but terrain around that avenue limits visibility of other possible avenues, leaders should normally position the Sentinel to provide area coverage. As follow-on Sentinels are employed, leaders can position Sentinels to cover individual avenues of approach and specific NAIs.

Mountain Operations

3-51. The terrain in a mountainous environment serves to canalize air movements reducing the options of available AAAs and minimizing cross-movement between AAAs. However, the terrain does provide ideal PUPs and loitering positions for threat rotary wing aircraft. In order for commanders to effectively counter the threat in mountainous terrain, they must identify opportunities to defeat the threat forward as they traverse the defined AAAs.

3-52. Employment of Sentinel teams in a mountainous environment provide significant challenges to the planner. Based on the severely limited trafficability of terrain, getting assets into appropriate positions where they can adequately cover defined AAAs is difficult. Commanders must coordinate and plan for the employment of Sentinel teams through the use of rotary wing lift assets in order to ensure teams can occupy the best early warning positions. Positioning Sentinels by air will often dictate that they be employed without the C²I node and therefore must rely on a SINCGARS data link to the C² node or direct link to the AMD fire unit through the ECIU and SINCGARS.

3-53. When employing Sentinel teams by air, the individual Sentinel team chief must ensure that systems are placed accurately in position according to the developed plan. Furthermore, they must ensure that positions do not silhouette the system. Once in place, Sentinels are difficult to displace. Therefore, positions should be selected that can support the offensive operation through multiple phases. Teams should also be equipped to conduct sustained operations.

3-54. Another significant challenge associated with employing Sentinel in mountainous terrain is the establishment of line-of-sight (LOS) communications between Sentinels, and from Sentinels to fire units. Planners must ensure the communication architecture established allows for continuous early warning dissemination to the entire force. One possible solution that must be planned for in order to assist in minimizing communication problems is the establishment of a data retransmission (retrans) site.

Military Operations in Urban Terrain

3-55. Light infantry units are ideal for conducting military operations in urban terrain (MOUT); therefore, it is likely that the Sentinel units in a LID may be utilized to support such an operation. Dense built-up areas characterize urban terrain. These built-up areas limit suitable employment positions, and negate the ability to achieve sufficient radar line of sight. Furthermore, LOS to other Sentinels and fire units is also degraded.

3-56. Employment of Sentinels in support of MOUT operations will vary according to the size of the urban area. However, planners should attempt to employ Sentinels outside of the built-up area. Sentinels should be employed initially on order to cover the movement of forces forward to secure the terrain surrounding the built-up area. Once the surrounding areas are secure, Sentinels can bound forward and occupy positions that provide the best LOS coverage of threat AAAs.

3-57. When urban areas are too large or terrain surrounding the built-up area does not support the employment of Sentinels on adjacent terrain, at least one, if not both of the Sentinels may need to be employed within the built-up area. Employment should not be thought of as an either/or, but as two techniques that may be combined. The difficulty in clearing and securing urban terrain will place the Sentinel sections at risk to snipers. Therefore, when employing Sentinels in urban terrain, leaders must be cautious to not commit the Sentinels too early. They must ensure that Sentinels do not enter the built-up area prior to the area being relatively secure. The use of a decision support template and matrix can greatly assist leaders in deciding when to commit Sentinels. For example, once sector one and two are secure, Sentinel Team One moves to BP 1.

3-58. Selecting adequate positions for Sentinels is often difficult in urban terrain. In order to effectively support military operations in urban terrain, Sentinels will often need to be employed on rooftops to achieve effective line of sight. Therefore, coordination for lift support is required. Once placed on rooftops, Sentinel team chiefs must ensure that positions are away from edges of the building to avoid making the system susceptible to small arms or sniper fire. Furthermore, as with mountain operations, once Sentinels are in place they are difficult to displace. Therefore, rooftops should be selected that can support the operations through multiple phases. Teams should also be equipped to conduct sustained operations.

Stability and Support Operations

3-59. Stability and support operations require AMD soldiers to be thoroughly trained on passive and active air defense measures. AMD soldiers must be trained to standard concerning visual aircraft recognition and ROE due to the possibility of like aircraft being flown by more than one of the forces involved and the digital air picture being less than perfect. Air and missile defense considerations are of greater importance in peace enforcement operations that deny or guarantee movement or enforce sanctions.

3-60. Confrontational parties may employ extensive measures such as cover and concealment, hand-held surface-to-air missiles, and light AMD artillery weapons to protect themselves from air attack. Since many targets will be in confrontational non-contiguous controlled areas, commanders with supporting AMD leaders must weigh the potential loss rate of aircraft against the returns that air interdiction missions might produce. Nevertheless, they should also consider that limitation of rotary and low-level fixed operations may be one of the goals of the confrontation. AMD leaders must also consider the use of unconventional air defense tactics, such as air defense ambushes at key IPB air avenues of approach, and the use of rocket-propelled grenades (if no MANPADS is available) against helicopters.

Chapter 4

Combat Service Support (Logistics)

This chapter discusses logistical concerns in employing Sentinels at the section level (two teams per section). Normally, a Sentinel platoon supports a divisional AMD battalion in support of divisional operations. Because of the scope of the divisional operations area (up to 200 x 400 kilometers), Sentinel sections are task-organized to each battery, METT-TC dependent. Coordinating and planning logistics is as important as tactical planning. A unit may be able to survive the first engagement, but unless it has properly coordinated logistical support, it will not survive the second fight. The logistical challenges for the Sentinel sections are based on the large distances involved and the lack of resources available to provide logistical support.

FUNCTIONAL OVERVIEW

4-1. Logistics is the acquisition, distribution, and care of material in storage and the salvage of supplies. Logistics includes the determination of kind and quantity of materials. It includes all items necessary to equip, maintain, and operate a military command. Logistical operations are conducted at all levels of command throughout the theater of operations and beyond. Of greatest concern to the Sentinel sections is how logistical operations take place internally within the division.

DIVISION LEVEL

4-2. The Division Support Command (DISCOM) provides division-level logistics to all organic and attached elements of the division. All DISCOMs consists of a Headquarters and Material Management Center (MMC), a main Support Battalion (MSB), three Forward Support Battalions (FSBs), and an Aviation Support Battalion (ASB) or Aviation Intermediate Maintenance (AVIM) organization. The DISCOM support operations section, MMC, and division medical operations center provide planning, management, and coordination to ensure support for all divisional and attached units.

MATERIAL MANAGEMENT CENTER

4-3. The MMC is organic to DISCOM. The MMC provides centralized and integrated material management for Class I (including water and Class VI management), Class II (including unclassified map supply and COMSEC software aids), and Classes III, IV, V, VII, and IX supplies. It does not manage Class VIII (medical) supplies and classified maps. The MMC determines requirements for development and technical supervision of division-authorized stockage lists, and operational readiness float lists, prescribed load lists, and operational readiness float lists. The MMC

requisitions all supplies requested by the division for which the center is responsible and directs their distribution.

MAIN SUPPORT BATTALION

4-4. The MSB provides division-level logistics support for divisional, and as necessary, non-divisional units located in the division support area. The base of operations for the MSB is the division support area (DSA). The DSA is normally in the division rear adjacent to air landing facilities and main supply routes (MSRs). The MSB medical company provides Echelon II medical care as well as preventive medicine, combat stress control, health service logistics, and optical fabrication support in the division area. The MSB maintenance companies perform divisionwide maintenance tasks to include providing direct support maintenance for division units in the division rear, and providing support that is beyond the capabilities of the FSB/ASB maintenance companies. These companies also maintain the authorized stockage list of Class IX supplies for the division. Other functions of the MSB include—

- Provide division-level logistics support of Class I, II, III, IV, VII, VIII, and IX supplies. See paragraph 4-30 for a description of classes of supply.
- Execute intermediate direct support maintenance for common and missile materiel to organic units in the DSA.
- Provide division-level and unit-level health service support on an area basis for troops located in the DSA.
- Operate material collection and classification facilities.
- Provide CSS information and advice to the DISCOM commander and staff on support capabilities provided by the battalion.
- Operate field services such as clothing exchange, bath, decontamination, and graves registration as required.
- Provide motor transport for the distribution of supplies, movement of reserves, assistance in the displacement of units, and to supplement the transport means available to division units as required.

FORWARD SUPPORT BATTALION

4-5. There is a forward support battalion (FSB) for each maneuver brigade within the division. The FSB consists of a supply company that handles all classes of supply (less engineer construction material and Class VIII); a maintenance company that provides DS maintenance of equipment organic to the supported brigade and conducts limited evacuation; and a medical company that provides combat health support to the supported brigade and provides Class VIII supplies as required.

4-6. The base of operations for the FSB is the brigade support area. The BSA is generally on a main supply route in the brigade rear area. In certain circumstances, FSB elements also provide critical support from forward logistics bases, usually on a temporary basis. This technique requires the FSB to echelon its assets with forward logistics elements operating from locations closer to supported units. This organization serves to reduce the

distance units must travel to receive support when fast-paced operations result in extended distances between supported units and the BSA.

AVIATION SUPPORT BATTALION

4-7. Heavy divisions are evolving to a structure which includes an ASB. Like an FSB, the ASB provides supply and ground maintenance. It also provides aviation intermediate maintenance to the division aviation brigade. It operates in the division rear near the aviation brigade's base of operations. FM 63-23 addresses the ASB.

AVIATION INTERMEDIATE MAINTENANCE

4-8. The aircraft maintenance company is either organic to the ASB or a separate company under the DISCOM. It provides AVIM support for the division aviation brigade aircraft, aircraft armament, avionics, and aircraft-peculiar items of ground support equipment. It also provides aircraft repair parts, aircraft and item support, and reinforces aviation unit maintenance.

BRIGADE AND BATTALION LEVEL

4-9. The heart of logistical operations within the maneuver brigade lies in the BSA. The BSA contains combat service support elements from the FSB, maneuver and combat support unit field trains, and selected division and corps resources. The BSA also consists of the brigade trains, forward area support teams, and other combat and combat support units.

4-10. Logistics operations in combat and combat support battalions are normally organized into support trains. Portions of support elements from the companies and the battalion headquarters displace from the combat elements into either field trains or combat trains. The support and supplies available vary greatly between the field and combat trains.

FIELD TRAINS

4-11. The field trains consist of the bulk of the battalion CSS elements. The field trains for all task forces and battalions operating as part of a brigade combat team (BCT) are located in the forward part of the BSA. Battalion field trains are organized to provide, manage, and execute overall logistical support for the battalion task force. Elements of the battalion S1, S4 (mess and supply), maintenance, and other support assets not positioned forward operate from the field trains.

COMBAT TRAINS

4-12. Battalion/TF combat trains are organized to provide immediate critical support for combat operations. They carry the minimum amount of supplies and equipment needed to sustain the force for short periods. Combat trains are positioned on the battlefield where they can quickly move forward and provide essential support to fighting forces. Combat trains provide battlefield recovery, maintenance, medical services, and some Class III and V support to the forward fighting force. Other elements of the combat trains

may include NBC decontamination assets, a communications team, and support elements from the FSB. The battalion S4 controls the combat trains, with assistance from the S1.

UNIT MAINTENANCE COLLECTION POINT

4-13. The battalion maintenance officer controls and organizes the UMCP to provide maintenance support for combat operations. The UMCP locates forward on the battlefield in the vicinity of, or collocated with, the combat trains to facilitate immediate availability of repair, recovery, and evacuation services.

LOGPAC OPERATIONS

4-14. The most effective means of pushing supplies forward to units on the battlefield is through the use of logistics packages (LOGPACs). LOGPACs consist of predetermined supply packages to include replacement personnel; returned-to-duty soldiers; supplies; repair parts; fuel and other petroleum, oils, and lubricants (POL) products; ammunition; and Class I supplies. LOGPACs are organized and put together at the field trains.

4-15. LOGPAC operations are a simple, effective way to accomplish routine resupply operations. The battery, battalion, and brigade standing operating procedures (SOPs) normally specify the exact composition and disposition of LOGPACs. LOGPAC operations are centrally organized at the BSA, and are structured to contain all anticipated supplies required to sustain a unit for a specified time (usually 24 hours or until the next LOGPAC operation). The battalion S4 plans and coordinates LOGPAC operations to ensure they fully support the commander's tactical plans.

4-16. LOGPACs move along main supply routes to a logistics release point (LRP) where the battery executive officer or team sergeant (depending on echelon being resupplied) takes control of his LOGPAC. The supported force S4, based on the tactical situation, determines LRP locations. LRPs normally are well forward and easily located. LRPs are planned and identified on the logistics support operations overlay.

4-17. In an AMD battery, the first sergeant assembles the LOGPAC in conjunction with the supported force's support team chief. Once the LOGPAC is prepared for movement, the battery ammunition sergeant moves the LOGPAC as part of the supported force's resupply convoy, which is led by the support team leader. In emergencies, a battery LOGPAC may be dispatched individually, but this technique is not recommended. When moving alone, the LOGPAC is especially vulnerable to attack, loss of communications, and disorientation.

SENTINEL LOGISTICS

4-18. Logistics operations for the Sentinel sections pose significant challenges to both the Sentinel section sergeants' leadership and the air defense leadership throughout the division. A Sentinel section, designed to support a brigade divisional AMD battery, will often be required to operate

within the division area of 200 x 400 kilometers. Based on this large area, coupled with the lack of adequate internal logistical resources available, air defense leaders must ensure that all elements of the Sentinel sections are integrated thoroughly into the existing divisional support structure.

4-19. Existing command and support relationships do not allow for much flexibility in how logistical support is provided. With the exception of an attached command relationship, there are no command or support relationships that provide doctrinally-based logistical support for the Sentinel sections. Furthermore, although the establishment of an attached command relationship may benefit logistical operations, it often proves to be tactically unsound because it also gives positioning authority of the attached Sentinels to the receiving unit. Therefore, the Sentinel sections will most likely provide support to the division as a whole, or be attached to a divisional AMD battery as opposed to some other element of the maneuver force.

4-20. Employment of Sentinels on the battlefield cannot be planned solely with the intent to ease logistical burdens. However, during the planning process, the ADO and Sentinel section sergeants must consider the availability of logistical support to Sentinel teams when developing the Sentinel scheme of maneuver. Depending on the command and support relationship established, there is a variety of battlefield assets can be used to help reduce the logistical burden imposed on the teams. Some of the most likely battlefield candidates for logistical support assistance to Sentinel teams include—

- DS AMD batteries supporting a maneuver brigade.
- DS AMD teams supporting maneuver TFs.
- General support AMD team elements (if operating near the GS element).
- The AMD battery's rear CP (typically located in the supported unit's BSA).

TEAM RESPONSIBILITIES

4-21. The Sentinel section sergeants and team chiefs are responsible for the planning and execution of CSS operations for the teams. The Sentinel section sergeants conduct logistics planning with the assistance of the team chiefs. The Sentinel section sergeants implement the logistics plan. In order to effectively plan logistics operations for the Sentinel teams, the Sentinel team leadership must understand the complete logistical framework from division through battalion/TF level, and conduct detailed coordination with applicable support units. The Sentinel resupply plan must get captured within the logistics rehearsal.

4-22. Although there are a variety of organizations throughout the division that the Sentinel teams can turn to for logistical assistance and support, AMD batteries in support of maneuver brigades will most often be required to manage the bulk of the support. Regardless of command and support relationships, Sentinel sections will normally operate forward in brigade

areas making the AMD battery the most likely candidate to provide the support required.

4-23. Considering the likelihood that Sentinel sections will receive most of their support through AMD batteries, certain actions by the Sentinel sections and teams are essential to ensuring support operations function smoothly. The Sentinel leadership must be proactive with establishing a good working relationship and not wait to act until the time support is required. Additionally, the AMD battery must ensure that Sentinel assets are fully integrated into the battery and BCT.

4-24. Sentinel section sergeants must identify as early as possible whose sector the Sentinel sections will be operating in. Once identified, they must ensure that sections understand the logistical SOPs and plan (to include CASEVAC) used by the AMD battery in that area. Furthermore, the battery already will have established a habitual relationship with their supported maneuver brigade. Therefore, it is critical that sections also understand the brigade SOPs and logistics plan. For example, if the brigade is using different colored flags for casualty identification, sections need to know what they are and have them on-hand.

4-25. In addition to being knowledgeable on brigade and AMD battery logistical plans, the Sentinel section sergeants also require a working knowledge of how AMD teams and supported TFs conduct CSS operations. This will ensure that the Sentinel teams are prepared for any contingencies and help alleviate concerns if there are changes in logistical support providers.

4-26. Once Sentinel personnel have developed a clear understanding of the logistical support structure of their adjacent or supported units, they need to further analyze any unique characteristics of logistical operations during the assigned mission. This includes identifying CSS locations, triggers for movement of CSS assets, and any modifications to established SOPs dictated by the type of mission. AMD rehearsals, along with the maneuver brigade/TF command and CSS rehearsals, help to clarify these unique characteristics. Therefore, it is essential that Sentinel team chiefs and section sergeants attend and participate at these rehearsals.

4-27. Once it has been determined that Sentinel sections are operating in the AMD battery's AO, the battery commander must coordinate the section's logistical support requirements with the supported brigade commander. Since the command and support relationship established will likely not dictate support requirements of the Sentinel teams or the battery itself, the battery commander must be prepared to articulate the criticality of receiving such support through the already established brigade CSS structure. The battery commander should address the lack of an organic AMD support structure to accomplish the mission, address the importance of the Sentinel assets and how they support the BCT's efforts, and present the commander with a viable plan for integrating AMD assets.

4-28. An AMD battery will use one of two approaches to conduct logistical support operations. The first is an approach in which the battery integrates itself into the existing brigade support structure. This method allows for timelier and less burdensome CSS operations since there is no requirement

for the battery staff to fully develop and execute support operations. By integrating, the battery simply provides some of its available support assets into the existing support structure. It moves as part of established LOGPACs, and receives equipment into the brigade from the divisional support structure. The second approach is to set up a separate battery train that supports the AMD battery. Although possible at times, this method places a tremendous burden on the battery itself, reduces the timeliness of overall CSS operations, and increases risk to the battery support assets. Regardless of the method, the Sentinel teams and sections must understand which logistical support system is being used.

4-29. During brigade and TF level rehearsals, AMD battery commanders and section sergeants must brief the scheme of maneuver for any Sentinel assets operating in the supported unit's AO. Furthermore, the battery commanders and section sergeants need to address logistical requirements of the Sentinels to the brigade/TF XO/S4 as part of the CSS rehearsal, and ensure the leadership knows the criticality of Sentinels to the overall mission.

CLASSES OF SUPPLY

4-30. The grouping of logistics into 10 classes provides meaningful major categories of types of supplies. Through this grouping method, items can be readily identified to each particular class. The following provides a description of each class of supplies:

- Class I Subsistence
- Class II General supplies, to include clothing, tentage, tools, administrative supplies.
- Class III Petroleum, fuels, and lubricants.
- Class IV Construction and barrier materials.
- Class V Ammunition.
- Class VI Personal demand items.
- Class VII Major end items (vehicles, radars, et cetera).
- Class VIII Medical material.
- Class IX Repair parts and components.
- Class X Nonmilitary program material.

OBTAINING LOGISTICS

4-31. The Sentinel section sergeant or the team chief is the combat CSS coordinator for the teams. The team chief digitally informs the section sergeant of logistical requirements and keeps the section sergeant digitally informed on the personnel and equipment status. The section sergeant should do all CSS coordination for the teams. See Figure 4-1.

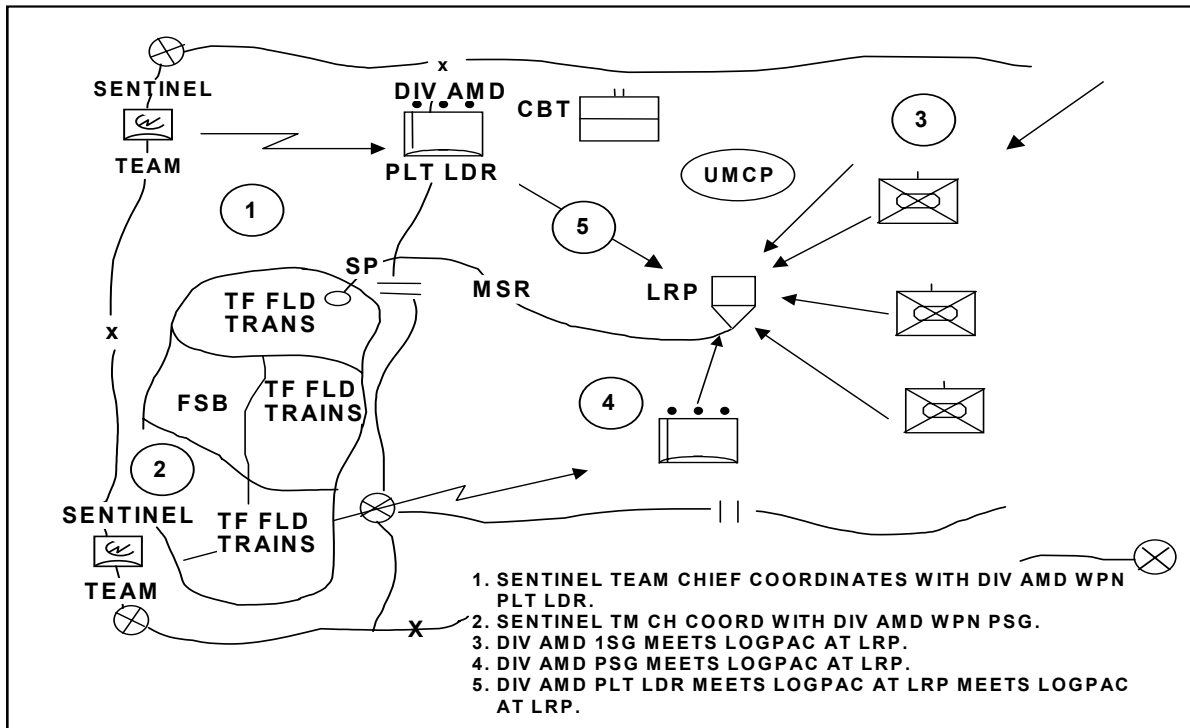

Figure 4-1. Obtaining Logistics

4-32. Normally, the section sergeant obtains all classes of supply per the battalion's SOP. When his teams are attached to a divisional AMD battery, the Sentinel section sergeant must coordinate with the battery commander or first sergeant to ensure that his teams receive the supplies they need. In addition, he must ensure that all classes of supply are available when his teams need them.

4-33. This digital request can be made with the divisional AMD battery in its area of operations. Once the supply requirement has been determined and requested, the section sergeant or team chief should be available at all times to pick up and distribute these supplies. The section sergeant should supervise this distribution.

4-34. Remember, the most often needed supplies are food (Class I), fuel (Class III), ammunition (Class V), and spare parts (Class IX). The section sergeant should always know the team's status and ensure the following:

- The teams are fed properly and have adequate water for drinking and personal hygiene.
- The teams are refueled in a concealed area or during hours of darkness if possible.
- Other supplies such as medical equipment; NBC equipment; tools; individual clothing and equipment listed in the common table of

allowances (CTA) 50; maps; batteries; and other expendable items are available before and during operations.

4-35. The section sergeant and team chiefs should ensure detailed and timely coordination is conducted to logistically support the tactical situation. Logistics, or lack of it, may determine the success or failure of combat operations. The Sentinel teams should be armed, fueled, and repaired as far forward as the tactical situation dictates. Forward support is accomplished through LOGPACs.

SENTINEL TEAMS

4-36. Any time the Sentinel teams have a command or support relationship of anything other than attached, there is no doctrinal basis for logistical support by the AMD battery or the supported maneuver force. The Sentinel teams must be integrated in the planning and preparation of the battery LOGPAC operations.

4-37. The teams should (digitally or vocally) coordinate with the divisional AMD battery on a constant basis to ensure the Sentinel team's LOGPAC consists of the items required, is formed at the field trains, and moved forward to the LRP. The Sentinel section sergeants must ensure that supplies, equipment, and personnel replacements, which are peculiar to the AMD mission, are digitally coordinated with the battery commander, the first sergeant or the battery supply sergeant. When the LOGPAC reaches the LRP, the Sentinel section sergeants or team chief, will take control of the LOGPAC.

4-38. The tactical displacement of the Sentinel sections may call for delegation of logistical responsibilities to the Sentinel section when close to a respective divisional AMD weapons team CP. Maintenance and evacuation of damaged vehicles will be coordinated with the battery. The location of UMCPs should be available and briefed to team personnel. When the battery has not responded to a request for support in sufficient time, the section sergeant should notify the first sergeant or the battery commander.

4-39. Evacuation of wounded personnel has to be coordinated with the maneuver brigade MEDEVAC personnel. This requires the Sentinel teams to be knowledgeable of the brigade's SOP on evacuation procedures. The teams must be informed of locations for casualty collection points, that is, brigade aid station (BAS), forward aid station (FAS), ambulance exchange point (AXP), and combat medics. When the tactical situation allows, organic team vehicles may be used to evacuate the wounded. The use of the FBCB² will facilitate this function.

LOGPAC OPERATIONS BY THE BATTERY HEADQUARTERS

4-40. LOGPAC operations by the battery headquarters follow the same battalion operations procedures with the exception of having different key players. The command relationship will likely be operational control or attached. In this situation, the battery will provide support. The battery support vehicles are maintained at the battery trains where they are loaded with the necessary supplies. The battery first sergeant, with the help of the

battery supply sergeant, forms the LOGPACs for each divisional AMD team based upon prior coordination. The first sergeant moves the LOGPACs forward along the established MSR to a designated LRP. When MSR and LRPs are located within the area of operations of another unit, the section sergeants or team chief may be required to coordinate for the use of MSRs or LRPs with the unit occupying the area. When the LOGPACs arrive at the LRP, the Sentinel section sergeant will take control of the teams' LOGPAC. Once the teams have been resupplied, the vehicle returns to the LRP, and the section sergeant gives his requests to the battery first sergeant for the next LOGPAC. See Figure 4-2.

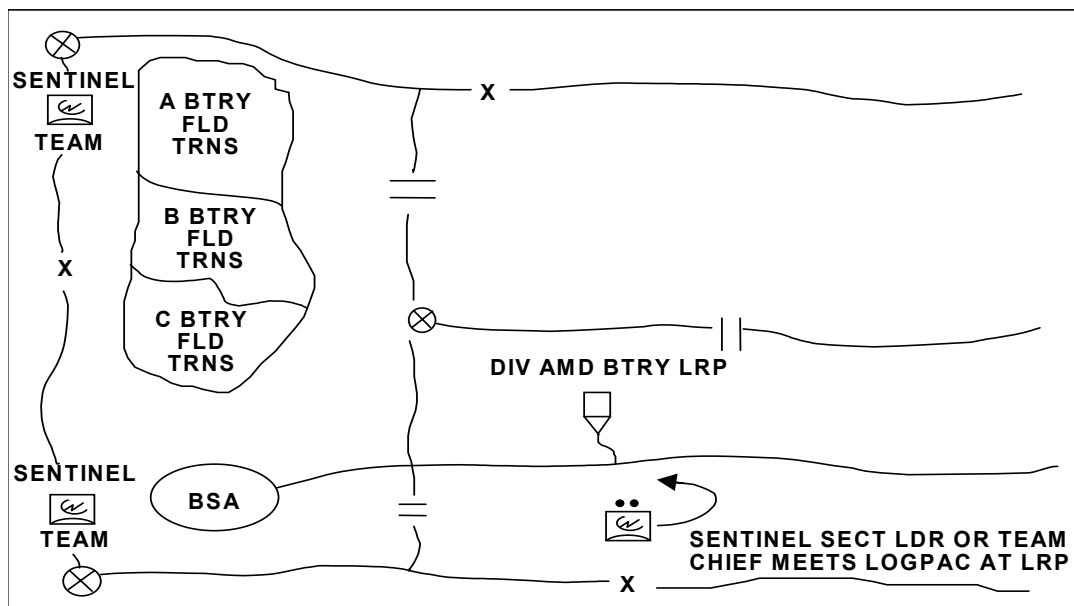

Figure 4-2. LOGPAC

4-41. LRP locations are determined either by the first sergeant or a designated representative (such as the battery XO). LRPs are based on the tactical situation. It is often useful or necessary to coordinate for the use of established MSRs or LRPs. The LRP should be close to where the Sentinel teams are employed and easy to locate. The MSR, LRP, UMCP, and train locations should be included on the operations overlay. SOP establishes the LOGPAC convoy arrival time at the LRP and length of time it remains.

4-42. The first sergeant or battery representative remains at the LRP as long as the LOGPAC vehicles are in the team areas. He should ensure the LOGPAC release and return takes place efficiently. To assist in the coordination for the next LOGPAC the following must be considered:

- Changes in logistical requirements reflecting any last-minute changes in task organizations.
- Digital reports on personnel, logistics, and maintenance from the team chiefs.
- First-hand updates on the tactical situation and logistical status.
- Delivery, receipt, and distribution of mail.

4-43. The battery maintenance personnel monitor and ensure the Sentinel teams are being supported in LOGPAC operations. The battery maintenance section will either push contact teams forward to the task force UMCPs or keep them on call at the battery rear CP in the BSA (METT-TC).

RESUPPLY OPERATIONS

4-44. Resupply operations are developed in the battery SOP. They are based on METT-TC and rehearsed in training. The methods of resupply are routine, emergency, and prestock. Routine resupply is used for the regular resupply of Class I, II, III, V and IX items, mail, and other battery items. Routine resupply takes place daily. Periods of limited visibility are best for resupply. If possible, resupply of Class III takes place at every opportunity. The LOGPAC technique is a simple and efficient way to conduct routine resupply operations. A LOGPAC is a centrally organized resupply convoy originating at the TF field trains. LOGPACs should contain all anticipated supplies required to sustain the battery for a specific time, usually 24 hours or until the next scheduled LOGPAC operation. Battalion and battery SOPs specify the exact composition and march order of the LOGPAC.

TEAM RESUPPLY TECHNIQUES

4-45. The section sergeant determines the resupply technique to be used based on METT-TC. This method will probably be used only when the Sentinels are GS to division and not collocated DS to an AMD battery. The technique selected for ground resupply will generally be the service station method, tailgate method, or a variation of the two. The section sergeant digitally or vocally briefs each team on the resupply method and establishes the resupply point. The section sergeant notifies the teams when the resupply point is prepared.

Service Station Method

4-46. Vehicles enter the resupply point following one-way traffic flow. Only those vehicles requiring immediate organizational or higher maintenance stop in maintenance holding areas before conducting resupply. If not already evacuated, WIA, KIA, and EPW are removed from team vehicles once they stop at the refuel or rearm point. Vehicles will rearm and refuel rotating to each point. The section sergeants will develop a plan so that not all Sentinels are down at any one time for resupply.

4-47. Sentinel teams rotate individually to feed, pick up mail, pick up supplies, and refill or exchange water cans. Once all vehicles have completed resupply, they move to the holding area where the section sergeants or team chief will conduct a precombat inspection (PCI). Based on the enemy situation, vehicles will disperse from their positions one vehicle at a time. They will be resupplied and return to the holding position until the whole section has been resupplied. Note: Medical evacuation vehicles are positioned an equal distance between the refuel and rearm points. This decreases the number of stops that a vehicle has to make. See Figure 4-3.

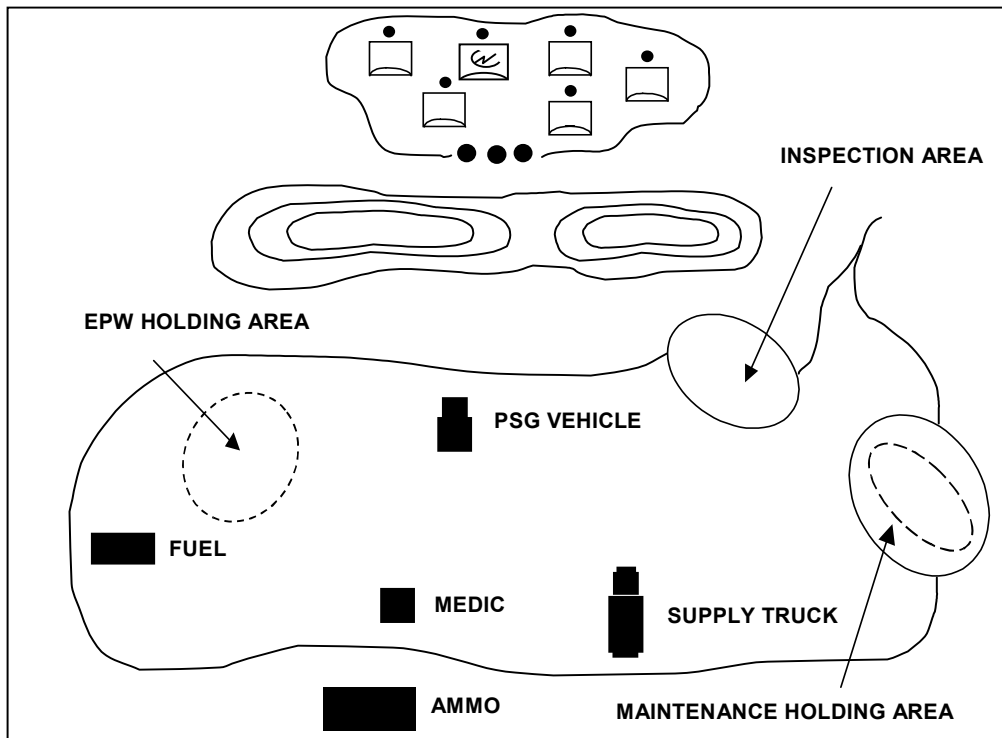

Figure 4-3. Service Station Method

Tailgate Method

4-48. When the tailgate method is used, combat vehicles remain in place or back out of their position a short distance so the resupply vehicle is not exposed. POL and ammunition trucks go to each vehicle position in turn. Team members rotate individually through feeding areas and pick up supplies, water, and mail. Sentinel team personnel bring KIA and personal effects to the holding area. Armored ambulances pick up critically wounded. Other injured are carried or walk to the ambulances for first aid. EPW are centralized and guarded. Vehicles requiring maintenance are brought to the maintenance area. The section sergeant or team chief at each vehicle completes inspections. See Figure 4-4.

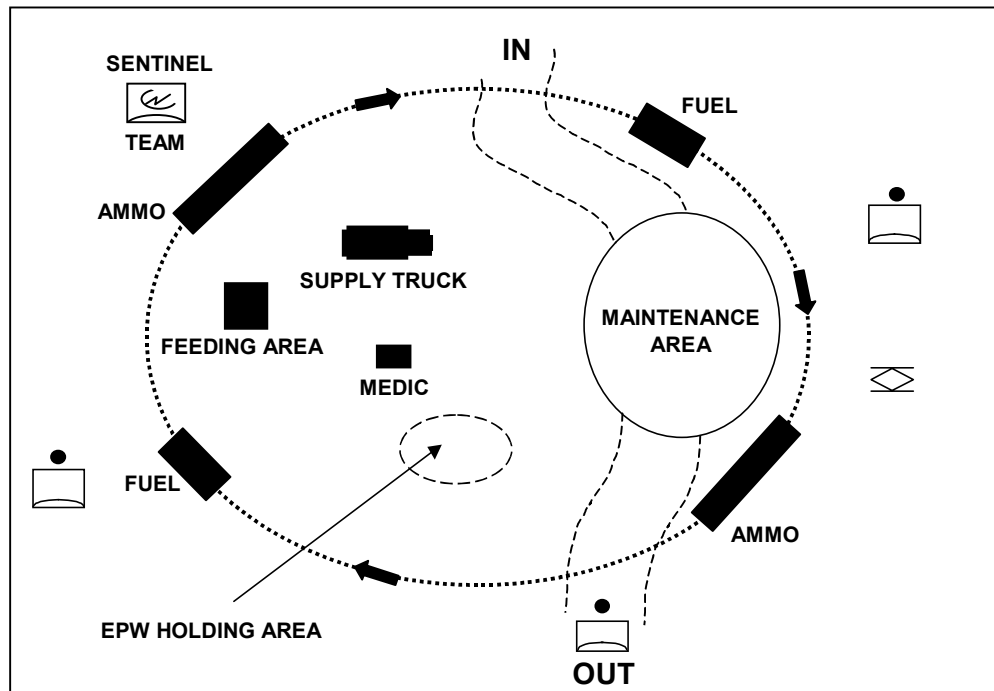

Figure 4-4. Tailgate Method

4-49. Note that the tailgate method is normally used only in an AA. If it is employed in forward positions, resupply must be masked by terrain. This procedure takes much longer than the service station method.

EMERGENCY RESUPPLY

4-50. Occasionally, usually as a result of combat, the battery may have such urgent need for resupply that it cannot wait for routine LOGPAC. Emergency resupply may involve Classes III, V, and VIII. Because it often occurs while in contact with the enemy, special techniques must be considered. When the task force and weapon platoons (and Sentinels) are under fire, limited supplies can be brought forward to the closest concealed position, where the tailgate method may be used. Individual vehicles drop back to resupply at the direction of the team chief, then return to fight. For resupply during a lull in combat, the service station method may be appropriate.

CROSS-LEVELING

4-51. Cross-leveling is not a technique of resupply but a way to make supplies last longer. It is the distribution of supplies evenly throughout the teams. Section sergeant and team chiefs in the assembly areas and after every action do it automatically. Cross-leveling usually takes place between team members. It is done for repair parts and all classes of supply. In some cases, supplies may be shifted in the teams to increase combat potential. For example, if a Sentinel team is preparing for movement but is short on ammunition and water, they may acquire or draw these items from the other

teams remaining in position. These teams would in turn be resupplied by the normal resupply system. The Sentinel section sergeants and team chiefs should manage cross-leveling between the teams.

PRE-POSITIONING SUPPLIES

4-52. Pre-positioned supplies are required in most defensive operations. Sentinels need more Class III because of generators. Normally, only Class V items are pre-positioned. The location and amount of pre-positioned ammunition and fuel for Sentinels must be carefully planned, and each vehicle driver must be digitally informed. Section sergeant or team chiefs should verify the locations of the sites during their reconnaissance and rehearsals.

4-53. Pre-positioned ammunition is on pallets, preferably in covered, protected positions. Other pre-positioning considerations include—

- Pre-positioning frees cargo vehicles to bring more fuel and ammunition forward.
- The possibility of capture or destruction of pre-positioned fuel and ammunition is a risk for the battery. The battery cannot guard pre-positioned sites with the manpower available.
- Pre-positioned Class III and ammunition must be far enough away from vehicles and individual fighting positions so that its destruction will not cause friendly vehicle or personnel casualties.
- Pre-positioning fuel is difficult. It requires covered sites separated from ammunition as well as additional equipment, including fuel transfer pumps and drums, blivets, and 5-gallon cans in quantity.

The following paragraphs describe the **two** main methods of pre-positioning supplies.

Method 1

4-54. Class V (supplies) is located in one place inside the AA or BP. See Figure 4-5. Each vehicle pulls into the central area to upload ammunition and rations, if any are pre-positioned. Pre-positioned fuel tankers are set up at the rear of the position, and refueling is done using the service-station method.

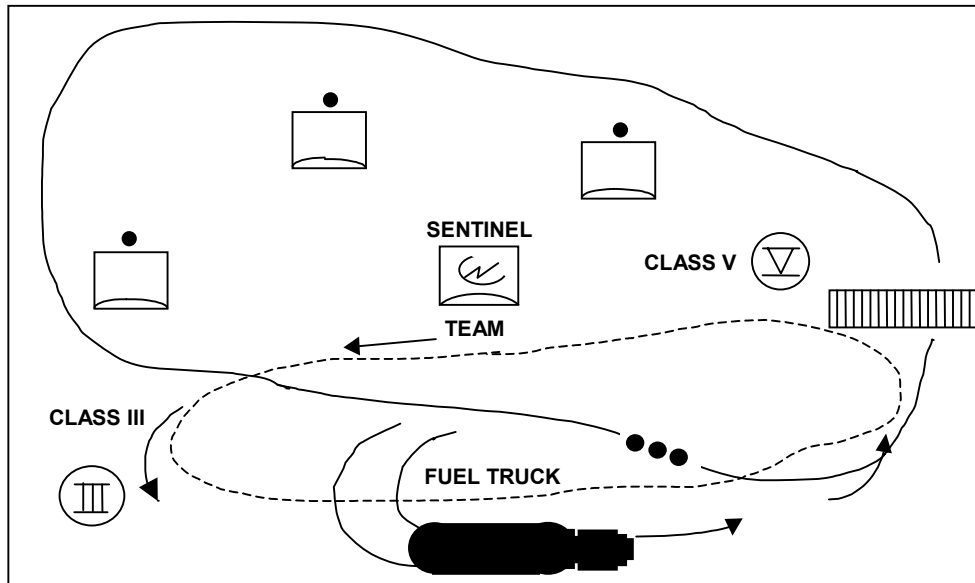

Figure-4-5. Service Station Method 1

Method 2

4-55. Class V (supplies) is pre-positioned at each vehicle position, and Class III fuel tankers are pre-positioned in one location for the entire section. In this method, Class V supplies are placed on the ground near each vehicle position and rearming begins. The fourth vehicle stops at the Class III fuel tanker located to the rear of the position and refuels. When the refueling vehicle is full, it moves into its position and begins to rearm while another vehicle moves to the refuel point. See Figure 4-6.

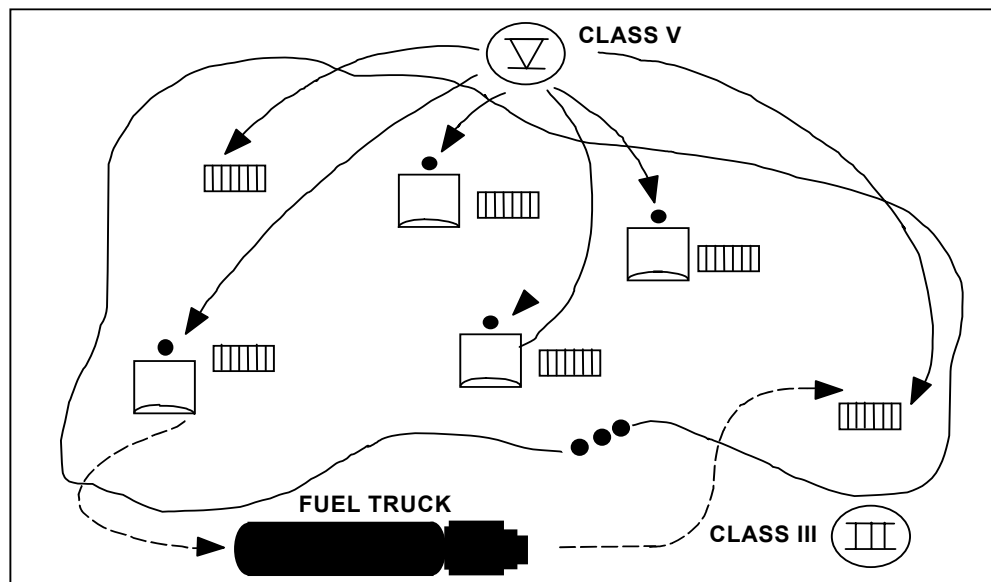

Figure 4-6. Service Station Method 2

PERSONNEL SERVICES

4-56. This consists of strength accounting, casualty reporting, replacement procedures, maintenance, personnel actions, and awards. According to local SOP, a strength accounting report is sent to battalion headquarters detailing Sentinel section strength by enlisted, and attached personnel. At higher echelons, these reports are used to determine which units receive priority when replacement troops arrive.

4-57. After digitally requesting a MEDEVAC for a casualty, a digital personnel status is filled out as soon as the tactical situation permits. This report is processed through administration/logistics (admin/log) channels. This information is used to inform the soldier's next of kin and to provide a statistical base for analysis of friendly or enemy activity. The platoon leader should be prepared to write a letter for the commander's signature to be sent to the soldier's next of kin.

REPLACEMENT OPERATIONS

4-58. Integrating replacements into teams is important. A new soldier arriving on the battlefield may be scared and disoriented as well as unfamiliar with local SOPs and the theater of operations. The section sergeants should welcome him to the unit, interview him, and introduce him to his team chief. The team chief introduces him to the team, briefs him on his duty position, and assigns him an experienced "buddy" to "look out" for him. This briefing should cover section recent, current, and future activities. Furthermore, this briefing should reinforce the fact that he is part of a good unit with a proud heritage (esprit de corps). The soldier should be told about the importance of SOPs and be given special information concerning the area of operations.

HEALTH SERVICES SUPPORT

4-59. At team level, health services support consists of: prevention, treatment, and evacuation of casualties. Emphasis is placed on prevention since soldiers may become combat ineffective due to nonbattle injuries or disease as often as due to combat. Understanding and applying the principles of field hygiene may eliminate these casualties, and prevent weather-related injuries. Leaders monitor the overall condition of their soldiers (see FM 21-10).

4-60. The leader must be prepared to treat and evacuate casualties. His treatment of serious casualties consists primarily of stabilizing the soldier until he can be evacuated to the nearest medical aid station. Casualties are treated and may be evacuated directly from the teams by vehicle or helicopter. If evacuated by vehicle, they are taken to the supported unit casualty collection point or battalion aid station designated in the OPORD. If evacuated by helicopter they are taken to the rear to the medical company in FSB to receive medical assistance.

4-61. Unit SOPs and operation orders address casualty evacuation in detail. They cover the duties and responsibilities of essential personnel, rank

methods of evacuation, and establish procedures for retrieving and safeguarding the weapons, ammunition, and equipment of casualties.

4-62. In war, leaders must be prepared to treat and evacuate casualties. The combat lifesaver program enhances the teams 's ability to provide immediate medical attention to casualties until evacuated to the nearest casualty collection point. The goal is to have one combat lifesaver in each Sentinel section.

MEDICAL EVACUATION PROCEDURES

4-63. The following provides the format for the Sentinel section and teams to request medical evacuation support from a medical element. The medical company has organic ground ambulances available and is often augmented with both ground and air evacuation resources from the corps/COMMZ medical evacuation battalion. For information concerning the medical evacuation request used in peacetime, refer to FM 8-10-6.

MEDICAL COMPANY EVACUATION SUPPORT

4-64. The medical company evacuates patients farther to the rear from Echelon I facilities. It also evacuates casualties on an area basis from units without organic evacuation resources—

- In the case of evacuating patients from Echelon I facilities, the required information is passed on the dedicated medical operations net.
- In the case of evacuating patients on an area basis, the request originates from the supported unit on the administration/logistics net. The evacuation request format (Table 4-1) is used.
- Medical evacuation requests are transmitted using secure means or are encrypted prior to transmission.

PREPARATION OF THE MEDICAL EVACUATION REQUEST

4-65. Brevity codes must be used in preparing all medical evacuation requests. The authorized codes are provided in Table 4-1. They are also provided in the standard SOI. Use of locally devised brevity codes is not authorized. If the unit preparing the request does not have access to secure communications, the request must be prepared in encrypted form.

TRANSMISSION OF THE REQUEST

4-66. The medical evacuation request should be made by the most direct communications means to the medical unit that controls the evacuation assets. The communications means and channels used depend on the situation (organization, communications means available, location on the battlefield, and distance between units). The primary and alternate channels to be used for requesting medical evacuation support are specified in the unit evacuation plan.

4-67. **Secure Transmissions.** Regardless of the type (secure or nonsecure) of communications equipment used in transmission, it is necessary to—

- Make contact with the intended receiver.
- Use the call sign and frequency assignments from the SOI.
- Use the proper radio procedures.
- Ensure that transmission time is kept to a minimum (20 to 25 seconds maximum).
- Provide the opening statement: "I HAVE A MEDEVAC REQUEST."

4-68. **Receiver Acknowledgment.** After the appropriate opening statement is made, the transmitting operator breaks for acknowledgment. Authentication by the receiving or transmitting unit should be done per TSOP.

4-69. **Clear Text and Encrypted Transmissions.** If secure communications equipment is used in transmission, the request will be transmitted in CLEAR TEXT. However, if the communications equipment used in transmission is not secure, the request must be transmitted in ENCRYPTED FORM with the following exceptions. The medical evacuation request line number identifier (Line 1, Line 2, Line 3, and so forth) is always transmitted in CLEAR TEXT. The call sign and suffix (Line 2) can be transmitted in CLEAR TEXT. When using DRYAD numeral cipher, the same "SET" line is used to encrypt the grid zone letters and the coordinates (Line 1 of the medical evacuation request). To avoid misunderstanding, a statement is made that the grid zone letters are included in the message. This must be accomplished unless the unit's SOP specifies that the DRYAD numeral cipher is to be used at all times.

4-70. **Letter and Numeral Pronunciation.** The letters and numerals that make up the request will be pronounced per radio procedures. In transmitting the request, the medical evacuation line number identifier will be given followed by the evacuation information (for example: "Line One. TANGO PAPA FOUR SIX FIVE THREE SEVEN NINER").

4-71. **Medical Evacuation Request Line Numbers 1 Through 5.** Line numbers 1 through 5 of the request must always be transmitted first. The information enables the evacuation unit to begin the mission and avoids unnecessary delay if the remaining information is not immediately available. The information for Lines 6 through 9 may be transmitted to the evacuation vehicle en route.

4-72. **Monitoring Requirement.** After transmission and acknowledgment the transmitting operator must monitor the frequency (Line 2 of the request) to wait for additional instructions or contact from the evacuation vehicle.

**Table 4-1. Procedures for Information Collection and
Medical Evacuation Request Preparation**

LINE	ITEM	EXPLANATION	WHERE/ HOW OBTAINED	WHO NORMALLY PROVIDES	REASON
1	Location of pickup site	Encrypt the grid coordinates of the pickup site. When using the DRYAD numeral cipher, the same "SET" line will be used to encrypt the grid zone letters and the coordinates. To preclude misunderstanding, a statement is made that grid zone letters are included in the message (unless unit SOP specifies its use at all times)	From map	Unit leader(s)	Required so evacuation vehicle knows where to pick up patient. Also, so that the unit coordinating the evacuation mission can plan the route for the evacuation vehicle (if the evacuation vehicle must pick up from more than one location)
2	Radio frequency, call sign, and suffix	Encrypt the frequency of the radio at the pickup site, not a relay frequency. The call sign (and suffix if used) of person to be contacted at the pickup site may be transmitted in the clear	From SOI	RTO	Required so that evacuation vehicle can contact requesting unit while en route (to obtain additional information, or change in situation or directions)
3	Number of patients by precedence	Report only applicable information and encrypt the brevity codes: A-URGENT B-URGENT-SURG C-PRIORITY D-ROUTINE E-CONVENIENCE If two or more categories must be reported in the same request, insert the word "BREAK" between each category	From evaluation of patient(s)	Medic or senior person present	Required by unit controlling the evacuation vehicles to assist in prioritizing missions

Table 4-1. Procedures for Information Collection and Medical Evacuation Request Preparation (Continued)

LINE	ITEM	EXPLANATION	WHERE/ HOW OBTAINED	WHO NORMALLY PROVIDES	REASON
4	Special equipment required	Encrypt the applicable brevity codes: A–None B–Hoist C–Extraction equipment D–Ventilator	From evaluation of patient/situation	Medic or senior person present	Required so that the equipment can be placed on board the evacuation vehicle prior to the start of the mission
5	Number of patients by type	Report only applicable information and encrypt the brevity codes. If requesting MEDEVAC for both types, insert the word “BREAK” between the litter entry and the ambulatory entry. L+ # of Pnt – Litter A + # of Pnt – Ambulatory (sitting)	From evaluation of patient(s)	Medic or senior person present	Required so that the appropriate number of evacuation vehicles may be dispatched to the pickup site. They should be configured to carry the patients requiring evacuation
6	Security of pickup site (wartime)	N–No enemy troops in area P–Possible enemy troops in area (approach with caution) E–Enemy troops in area (approach with caution) X–Enemy troops in area (armed escort required)	From evaluation of situation	Unit leader	Required to assist evacuation crew in assessing the situation and determining if assistance is required. More definitive guidance can be furnished the evacuation vehicle while it is en route (specific location of enemy to assist an aircraft in planning its approach)

Table 4-1. Procedures for Information Collection and Medical Evacuation Request Preparation (Continued)

LINE	ITEM	EXPLANATION	WHERE/ HOW OBTAINED	WHO NORMALLY PROVIDES	REASON
6	Number and type of wound, injury, or illness (peace-time)	Specific information regarding patient wounds by type (gunshot or shrapnel). Report serious bleeding, along with patient blood type, if known	From evaluation of patient	Medic or senior person present	Required to assist evacuation personnel in determining treatment and special equipment needed
7	Method of marking pickup site	Encrypt the brevity codes: A–Panels B–Pyrotechnic signal C–Smoke signal D–None E–Other	Based on situation and availability of materials	Medic or senior person present	Required to assist the evacuation crew in identifying the specific location of the pickup. Note that the color of the panels or smoke should not be transmitted until the evacuation vehicle contacts the unit (just prior to its arrival). For security, the crew should identify the color and the unit verify it.
8	Patient nationality and status	The number of patients in each category need not be transmitted. Encrypt only the applicable brevity codes: A–US military B–US civilian C–Non-US military D–Non-US civilian E–EPW	From evaluation of patient	Medic or senior person present	Required to assist in planning for destination facilities and need for guards. Unit requesting support should ensure that there is an English-speaking representative at the pickup site

Table 4-1. Procedures for Information Collection and Medical Evacuation Request Preparation (Continued)

LINE	ITEM	EXPLANATION	WHERE/ HOW OBTAINED	WHO NORMALLY PROVIDES	REASON
9	NBC contamination (war time)	Include this line only when applicable. Encrypt the applicable brevity codes: N–Nuclear B–Biological C–Chemical	From situation	Medic or senior person present	Required to assist in planning for the mission. (Determine which evacuation vehicle will accomplish the mission and when it will be accomplished.)
9	Terrain description (peacetime)	Include details of terrain features in and around proposed landing site. If possible, describe relationship of site to prominent terrain feature (lake, mountain, tower)	From area survey	Personnel at site	Required to allow evacuation personnel to assess route/avenue of approach to area. Of particular importance if hoist operation is required.

ECHELONS OF MEDICAL CARE

4-73. Combat health support is arranged in *echelons of care*. Each echelon reflects an increase in medical capabilities while retaining the capabilities found in the preceding echelon.

ECHELON I

4-74. The first medical care a soldier receives is provided at Echelon I (also referred to as unit-level medical care). This echelon of care includes—

- Immediate lifesaving measures.
- Disease and nonbattle injury prevention.
- Combat stress control preventive measures.
- Patient collection.
- Medical evacuation from supported units to supporting MTFs.

4-75. Treatment is provided by designated combat medics or treatment squads (BASs) in conventional forces. In Army special operations forces, Echelon I treatment is provided by special operations combat medics (SOCMs), special forces medical sergeants (SFMSs), or physicians or physician assistants (PAs) at forward operating bases, special forces operating bases, or in joint special operations task force areas of

responsibility. Major emphasis is placed on those measures necessary for the patient to RTD, or to stabilize him and allow for his evacuation to the next echelon of care. These measures include maintaining the airway, stopping bleeding, preventing shock, protecting wounds, immobilizing fractures, and performing other emergency measures, as indicated.

4-76. The combat medic is assisted in his duties by nonmedical personnel performing first-aid procedures. First aid is administered by an individual (self-aid, buddy aid) and by the combat lifesaver. Each individual soldier is trained to be proficient in a variety of specific first-aid procedures. These procedures include aid for chemical casualties with particular emphasis on lifesaving tasks. This training enables the soldier or a friend to apply first aid to alleviate a life-threatening situation.

4-77. The combat lifesaver is a member of a nonmedical unit selected by the unit commander for additional training beyond basic first-aid procedures. A minimum of one individual per squad, crew, team, or equivalent-sized element should be trained. The primary duty of this individual does not change. The additional duty of the combat lifesaver is to provide enhanced first aid for injuries (based on his training) before the combat medic arrives. The combat lifesavers training is normally provided by medical personnel assigned, attached, or in direct support of the unit. The senior medical person designated by the commander manages the training program. Members of SF operational detachment A teams receive enhanced first-aid training at the combat lifesaver level.

4-78. Echelon I medical treatment is provided by the combat medic or by the physician, PA, or medical specialist in the BAS. Emergency medical treatment (immediate far forward care) consists of those lifesaving steps that do not require the knowledge and skill of a physician. The combat medic is the first individual in the CHS chain who makes medically substantiated decisions based on medical MOS-specific training. The SFMS receives more advanced training than the conventional force combat medic, as the SFMS may be required to maintain patients for longer periods of time under austere conditions. The physician and the PA in a treatment squad are trained and equipped to provide advanced trauma management to the battlefield casualty. This element also conducts routine sick call when the tactical situation permits. Like elements provide this echelon of medical care to division, corps, and EAC units.

4-79. Echelon I care is provided by—

- Medical teams/sections of combat and combat support battalions/squadrons.
- Divisional medical companies.
- Corps and EAC area support medical companies.
- Special forces medical sergeants, PAs, and physicians assigned to specialforces groups, special operations support battalions, and SOCMs, PAs, and physicians assigned to Ranger regiments.

ECHELON II

4-80. At Echelon II, care is rendered at the clearing stations (division or corps), which are operated by the treatment teams of the medical company. Here the casualty is examined and his wounds and general status are evaluated to determine his treatment and evacuation precedence, as a single casualty among other casualties. Emergency medical treatment, including resuscitation is continued and, if necessary, additional emergency measures are instituted, but they do not go beyond the measures dictated by immediate necessities. The clearing station has a whole blood capability and limited x-ray, laboratory, and dental support. Echelon II CHS also includes PVNTMED and CSC assets in the division (main support medical company) and in the corps (area support medical battalion [ASMB]). Those patients who can RTD within one to three days are held for treatment. Company-sized medical units organic to brigades, divisions, and ASMBs typically perform these functions. Patients who are nontransportable due to their medical condition may receive immediate surgical care from a forward surgical team (FST) collocated with a division or corps medical company. A discussion of the FST is contained in FM 8-10-25. Army special operations forces units do not have organic Echelon II resources and are dependent upon theater assets for this echelon of care. Support is provided on an area support basis by the ASMB.

ECHELON III

4-81. At Echelon III, the patient is treated in an MTF staffed and equipped to provide resuscitation, initial wound surgery, and postoperative treatment. Those patients who are expected to RTD within the theater evacuation policy are relegated to a facility that has the capability for reconditioning and rehabilitation.

ECHELON IV

4-82. At Echelon IV, the patient is treated in a hospital staffed and equipped for general and specialized medical and surgical care. It stabilizes the patient for further evacuation out of the theater, or for reconditioning and rehabilitation prior to RTD.

ECHELON V

4-83. Echelon V medical care is found in support base hospitals. Mobilization requires expansion of military hospital capacities and the inclusion of Department of Veterans Affairs and civilian hospital beds in the CHS system to meet the increased demands created by the evacuation of patients from the TO. The support base hospitals represent the most definitive medical care available within the CHS system.

Appendix A

Air and Missile Defense Orders and Annexes

This appendix provides the format and content of different types of digital orders and annexes. Thoroughly understanding and using them allows the Sentinel platoon leader to organize his thoughts and concisely convey them to his subordinates.

<p>(Classification)</p> <p>(Change from oral orders, if any) (Optional)</p> <p><i>A WARNING ORDER DOES NOT AUTHORIZE EXECUTION UNLESS SPECIFICALLY STATED</i></p> <p>Copy__of__copies Issuing headquarters Place of issue Date-time group of signature Message reference number</p> <p>WARNING ORDER _____</p> <p>References: Refer to higher headquarters OPLAN/OPORD, and identify map sheet for operation. (Optional)</p> <p>Time Zone Used Throughout the Order: (Optional)</p> <p>Task Organization: (Optional) (See paragraph 1c.)</p> <p>1. SITUATION:</p> <p>a. Enemy forces. Include significant changes in enemy composition, dispositions, and courses of action. Information not available for inclusion in the initial WARNO can be included in subsequent warning orders.</p> <p>b. Friendly forces. (Optional) Only address if essential to the WARNO.</p> <p>(1) Higher commander's mission. (2) Higher commander's intent.</p> <p>c. Attachments and detachments. Initial task organization; only address major unit changes.</p> <p>2. MISSION. Issuing headquarters' mission at the time of the WARNO. This is nothing more than higher headquarters' restated mission or commander's decisions during MDMP.</p> <p>3. EXECUTION.</p> <p>Intent:</p> <p>a. Concept of operations. Provide as much information as available; this may be done during the initial WARNO.</p> <p>b. Tasks to maneuver units. Any information on tasks to units for execution, movement to initiate, reconnaissance to initiate, or security to emplace.</p> <p>c. Tasks to combat support units. See paragraph 3b.</p> <p>d. Coordinating instructions. Include any information available at the time of the issuance of the WARNO. It may include the following:</p> <table border="0"><tr><td>• CCIR.</td><td>• Time line.</td></tr><tr><td>• Risk guidance.</td><td>• Guidance on orders and rehearsals.</td></tr><tr><td>• Deception guidance</td><td>• Orders group meeting (attendees, location, and time).</td></tr><tr><td>• Specific priorities, in order of completion.</td><td>• Earliest movement time and degree of notice.</td></tr></table> <p>4. SERVICE SUPPORT. (Optional) Include any known logistics preparation for the operation.</p> <p>a. Special equipment. Identifying requirements and coordinating transfer to using units.</p> <p>b. Transportation. Identifying requirements and coordinating for pre-position of assets.</p> <p>5. COMMAND AND SIGNAL. (Optional)</p> <p>a. Command. State the chain of command if different from unit SOP.</p> <p>b. Signal. Identify current SOI edition, and pre-position signal assets to support operation.</p> <p>ACKNOWLEDGE: (Mandatory)</p> <p style="text-align: right;">NAME (Commander's last name) RANK (Commander's rank)</p> <p>OFFICIAL: (Optional)</p> <p style="text-align: center;">(Classification)</p>	• CCIR.	• Time line.	• Risk guidance.	• Guidance on orders and rehearsals.	• Deception guidance	• Orders group meeting (attendees, location, and time).	• Specific priorities, in order of completion.	• Earliest movement time and degree of notice.
• CCIR.	• Time line.							
• Risk guidance.	• Guidance on orders and rehearsals.							
• Deception guidance	• Orders group meeting (attendees, location, and time).							
• Specific priorities, in order of completion.	• Earliest movement time and degree of notice.							

Figure A-1. Warning Order

ANNEX G (AIR AND MISSILE DEFENSE) TO OPERATION ORDER NO _____

1. SITUATION

a. Enemy. See Annex B (Intelligence).

(1) **Terrain.** Identify most likely enemy ingress and egress routes.

(2) **Weather.** Identify enemy aircraft all-weather capabilities and limitations.

(3) **Enemy air capability and/or activity.**

(a) **Air threat data.** Air-capable organizations including air platforms by number and type.

(b) **Additional air threat information.** Include air threat information pertinent to the operation but not covered in the Intelligence Annex. Highlight specific air threat considerations such as sortie rates, subordination of air elements to ground units, ordnance peculiarities, target preferences, tactics, and recent significant activities and tactical ballistic missile threat.

(c) **Air avenues of approach.** List all expected air avenues of approach and identify by air platform their potential users. List all beginning points. List all known beginning points and describe avenue of approach as it goes through the area of interest.

b. Friendly situation. List AMD mission at all applicable levels. Describe how the air and missile defense plan integrates with higher-echelon plans:

(1) **Higher units.** Outline higher AMD unit concept and plans.

(2) **Adjacent units.** Outline adjacent AMD unit concept and plans.

(3) **Supporting elements.** Note supporting units and support relationships.

c. Attachments and detachments. Identify air defense resources attached from other commands and identify those air defense resources detached.

2. MISSION**3. EXECUTION**

a. Scheme of AMD support. Commander's overall AMD plan to include the concept, objectives, and priorities.

b. Tasks to subordinate AMD units. Briefly discuss AMD plan, command and support relationships, and priority of protection.

c. Coordinating instructions. Instructions applicable to two or more subordinate units. Include references to other applicable annexes.

- Weapon control status (WCS) and WCS authority. Include any plans to change WCS.

- Hostile criteria. Basic rules the commander has established to assist in the identification of friendly or hostile air vehicles. Include preplanned changes.

- Rules of engagement. Address ROE unique to the operation or points in the operation where changes are intended. Include use of supplemental fire control measures.

- Passive air defense. Specific passive air defense measures that all units should take to protect themselves from air and missile attack or surveillance during this operation.

- Combined arms for air defense. Specific techniques units should use to help in defending themselves against an air or a missile attack or surveillance.

- Early warning. Method and format for passing early warning to the entire force.

4. SERVICE SUPPORT**5. COMMAND AND SIGNAL**

a. Command.

b. Signal:

- Identification, friend or foe (IFF) code edition and book number.

- Communications links for early warning equipment.

Figure A-3. Annex G (Air and Missile Defense) to Operation Order

<p>(Classification) (Change from oral orders, if any)</p>	<p>Copy__of__copies Issuing headquarters Place of issue Date-time group of signature Message reference number</p>
<p>OPERATION PLAN (ORDER)_____ (code name) (number)</p>	
<p>References:</p>	
<p>Time Zone Used Throughout the Plan (Order):</p>	
<p>Task Organization:</p>	
<p>1. SITUATION</p> <ul style="list-style-type: none"> a. Enemy forces. b. Friendly forces. c. Attachments and detachments. d. Assumptions (OPLAN only). 	
<p>2. MISSION</p>	
<p>3. EXECUTION</p> <p>Intent:</p> <ul style="list-style-type: none"> a. Concept of operations. <ul style="list-style-type: none"> (1) Maneuver (2) Fires (3) Reconnaissance and Surveillance (4) Intelligence (5) Engineer (6) Air and Missile Defense (7) Information Operation b. Tasks to maneuver units. c. Tasks to combat support units. <ul style="list-style-type: none"> (1) Intelligence (2) Engineer (3) Fire Support (4) Air and Missile Air Defense (5) Signal (6) NBC (7) Provost Marshal (8) PSYOP (9) Civil Military (10) As required d. Coordinating instructions. <ul style="list-style-type: none"> (1) Time or condition when a plan or order becomes effective (2) CCIR (3) Risk reduction control measures (4) Rules of engagement (5) Environmental considerations (6) Force protection (7) As required 	
<p>4. SERVICE SUPPORT</p> <ul style="list-style-type: none"> a. Support concept. b. Materiel and services. c. Medical evacuation and hospitalization. d. Personnel. e. Civil military. f. As required. 	

Figure A-4. Operation Plan (Order)

5. COMMAND AND SIGNAL	
<ul style="list-style-type: none"> a. Command. b. Signal. 	
ACKNOWLEDGE:	NAME (Commander's last name)
	RANK (Commander's rank)
OFFICIAL:	
Name and position	
ANNEXES:	_____
	(Classification)

Figure A-4. Operation Plan (Order)(Continued)

<p>_____</p> <p>(Classification)</p> <p>(Change from oral orders, if any)</p>	<p>Copy__of__copies</p> <p>Issuing headquarters</p> <p>Place of issue</p> <p>Date-time group of signature</p> <p>Message reference number</p>
MOVEMENT ORDER _____	
References:	
Time Zone Used Throughout the Order:	
Task Organization:	
1. SITUATION	
<ul style="list-style-type: none"> a. Enemy forces. b. Friendly forces. c. Attachments and detachments. 	
2. MISSION	
3. EXECUTION	
<ul style="list-style-type: none"> a. Concept of movement. b. Tasks to subordinate units. c. Detailed timings. d. Coordinating instructions. <ul style="list-style-type: none"> (1) Order of march. (2) Routes. (3) Density. (4) Speed (include catch-up speed). (5) Method of movement. (6) Defense on move. (7) Start, release, or other critical points. (8) Convoy control. (9) Harbor areas. (10) Instructions for halts. (11) Lighting. (12) Air support. 	

Figure A-5. Movement Order

Appendix B

Reconnaissance, Selection, and Occupation of Position

This appendix addresses the reconnaissance, selection, and occupation of position (RSOP) requirements and their applications. The procedures for RSOP have been developed to facilitate the rapid, orderly, and safe movement of Sentinel teams on the battlefield. The six Sentinel teams managed by the three section sergeants will displace frequently, whether deployed in forward or flank areas. They move to support the divisional AMD batteries in response to mission changes. They also move to enhance survivability. RSOP must be part of a unit's SOP, be clearly understood, and be practiced repeatedly by all members of the Sentinel platoon.

METHODS OF RECONNAISSANCE

B-1. Reconnaissance is the thorough examination of terrain. It determines its suitability for accomplishment of the mission. The three methods of reconnoitering are: digital map, aerial, and ground.

DIGITAL MAP

B-2. A study and analysis of a digital tactical map will provide an appreciation of the terrain and show the best route to the selected location. A map reconnaissance—

- Precedes all other methods. A hard copy map should always be available for the area of operation.
- Allows quick examination of large areas. This is faster than other reconnaissance methods.
- Does not determine current conditions of the area. Therefore, examine all overlays (for example, engineer and chemical). Use a current map because a dated map may provide an inaccurate representation of the area. Verify line of sight (LOS).
- Ensures the most security. A map reconnaissance can be conducted in a secure location.

AERIAL

B-3. The section sergeant or team chief can also use available aircraft to see the terrain. An aerial reconnaissance—

- Provides the fastest way to see the terrain.
- Is limited by aircraft availability, weather, and light conditions.
- Is still an imperfect reconnaissance. Masked areas inhibiting LOS, ground conditions, and local threat cannot be determined unless the aircraft lands.
- Is less secure than a map reconnaissance. Aircraft activity in an area exposes soldiers to threat activity and also reveals an interest in a particular area.

GROUND

B-4. A ground reconnaissance is an on-site examination of the terrain. A ground reconnaissance—

- Is the most accurate and desirable type of reconnaissance. The route can be evaluated for trafficability, obstacles, choke points, and key terrain. Firing positions, fields of fire, and air avenues of approach can be analyzed for planning finalization.
- Is time-consuming. Covering the distances over potential routes and checking alternate positions takes time. The ground reconnaissance is the slowest method of reconnaissance.
- Is dangerous. The small reconnaissance party could be subjected to threat observation en route or at the objective area.

B-5. If ground or aerial reconnaissance cannot be performed, engineer terrain teams may be able to provide necessary information. Plans can be made for the reconnaissance to include routes, rally/release points (RPs), assembly points, and assembly times for the reconnaissance party. If time is limited and the unit must move before the reconnaissance party returns, road guard positions are selected and soldiers necessary for these tasks are included in the RSOP party. Actual inspection of the chosen routes and positions on the ground is desirable to confirm selections made from the map, or to make necessary adjustments in plans.

RSOP SEQUENCE

B-6. Divisional AMD Sentinels are deployed as teams, and each Sentinel team is deployed no farther apart than 60 kilometers (METT-TC), which allows 20 kilometers of radar coverage overlap between Sentinels. This prevents an enemy aerial platform from slipping between two radars. The Sentinel section (two teams) will have to create its RSOP party. The following paragraphs detail the sequence of actions for conducting the RSOP.

RECEIVE/ISSUE DIGITAL MOVEMENT WARNING ORDER

B-7. The Sentinel section sergeant returns to the assembly area, issues a movement warning order, and briefs his team chiefs on the new mission. The movement warning order can be—

- Written, digital, or verbal.
- Delivered in person.
- Passed over digital tactical communications nets.

B-8. The warning order must include, as a minimum: situation, mission, execution (concept of operations, tasks to maneuver and combat support units, and coordinating instructions), and an acknowledgement. See Appendix A for a warning order format.

MAKE A DIGITAL MAP RECONNAISSANCE

B-9. Making a digital map reconnaissance is a quick way to conduct a tentative reconnaissance. The best way is to actually look at the area and walk the terrain. The positions of the six teams and each section CP are plotted on a map

and represent the best locations for broadcasting track data to the divisional AMD assets. The team chiefs will consider the terrain, weather, and the factors of METT-TC. Alternate positions should be identified at this time, especially if jamming has been detected. After the Sentinel positions have been plotted on a map, positions for check points (CPs) and primary and alternate routes are selected and plotted. The Sentinel team chief identifies a digital reconnaissance route by conducting a digital map reconnaissance to the proposed area. Positions selected by map reconnaissance must be confirmed by additional reconnaissance if the tactical situation allows.

PLAN THE GROUND RECONNAISSANCE

B-10. Perform a ground reconnaissance to select the best Sentinel team positions, march routes, SPs, RPs, CPs, and communications sites. The Sentinel section sergeants should (digitally or by voice) coordinate with the local divisional AMD battery commander and the supported unit battalion S3 to determine what areas the divisional AMD assets and maneuver forces plan to occupy. Mutual agreement must be established to make the best use of the available terrain. The Sentinel team chiefs select the personnel and equipment needed to conduct the ground reconnaissance. The unit SOP will establish the normal composition and responsibilities of the party. The reconnaissance party for the team location should consist of at least the team chief, driver, and RTO.

BRIEF NEXT-IN-COMMAND – ISSUE ORDERS

B-11. After the senior team chief (section sergeants) finalizes and coordinates the plan, he briefs his team and the other team covering all elements of a five-paragraph operation order (situation, mission, execution, service support, and command and signal) and indicates when the RSOP party will depart the present position. He identifies at least the SP and the RP. His briefing and issuing of orders should include instructions on continued operations in the absence of key personnel.

CONDUCT RECONNAISSANCE AND SELECT POSITIONS

B-12. As soon as RSOP preparations are complete, the team chief departs with the reconnaissance party. He ensures that the selected primary route meets equipment (height, weight, and width) requirements, is passable, and avoids possible ambush locations. He positions road guides as required. He may keep the team posted on his progress by referencing predetermined checkpoints. As the RSOP party approaches the new location, the team chief checks the area.

B-13. The team chief must ascertain if the tentative map-selected locations will allow immediate occupation for accomplishment of the mission. Ground reconnaissance verifies whether the terrain provides good natural concealment; has access roads for primary and alternate route in and out of the position; provides good observation, LOS to divisional AMD assets; and has firm ground that will support the weight of the equipment.

B-14. NBC and mine detection teams check the immediate area to ensure it is free of contamination and mines. A total security plan is then placed in effect. This includes positioning personal weapons overlooking the main ground avenue of approach and alternate routes into the position, and establishing other

security positions around the area to preclude gaps in the perimeter. Communications are established with all the positions. Proposed positions plotted during the map reconnaissance should be used if possible. Team chiefs reconnoiter the positions assigned to them, select tentative sites and observation posts (OPs), and confirm them with the section sergeants. The team chief reconnoiters the area and selects the site for the C² node. He visits each proposed position, and supervises or assists as needed. After approving the positions, the Sentinel section sergeants inform the divisional AMD S3 and battery commander of the Sentinel locations.

B-15. Positions selected must be the best available for broadcasting track data, communications, accessibility, and survivability. The following specific characteristics must be considered in selecting static sites for the Sentinel teams:

- Location has good LOS to the battery and elements and the ABMOC (METT-TC).
- Cover and concealment are available.
- Alternate entrance and exit routes are available.
- Position is defensible against ground attack.
- Position is collocated (1 kilometer) with an AMD weapon system for air and or ground protection.

B-16. The following are characteristics which must be considered in selecting sites for Sentinel teams:

- Primary and secondary positions.
- Communications with section sergeants and the other team in the section.
- Positions should be within 100 meters of plotted positions in original Sentinel design. If not, it may need to be redesigned.
- Positions make maximum use of available cover and concealment to facilitate survivability.

B-17. When Sentinels broadcast from a position and jamming has been detected, that position may be compromised. The Sentinel team then should locate to the alternate position. Sentinel teams will select primary alternate, and supplementary positions during the ground reconnaissance. Routes into and out of these positions must be selected and prepared as necessary. The following positions are normally selected by ground reconnaissance:

- Primary position. A position from which the Sentinel team intends to accomplish its tactical mission.
- Alternate position. A position to which the Sentinel team moves when the primary position becomes untenable or unsuitable for carrying out the assigned mission. The alternate position must be far enough away to prevent its being rendered untenable by the same action that affected the primary position. The alternate position must meet all the requirements of the primary position.
- Supplementary position. A position that provides the best means to accomplish a task that cannot be accomplished from the primary or alternate positions.

B-18. Care must be exercised to avoid placing positions near terrain features easily recognized from the air. Positions are more vulnerable to enemy fires (once spotted near an identifiable object).

PREPARE TO OCCUPY POSITIONS

B-19. After the team chiefs have selected their positions, they ensure the ground guides know exactly where they want the vehicles and equipment emplaced. Preparation should include marking the location of each major piece of equipment (as required). Everyone at the new position is given the new challenge and password, information on any known enemy activity in the area, and the approximate arrival time, location, and order of vehicles for the main party.

MOVE TO NEW POSITIONS

B-20. The team chiefs inform the rest of the teams of the results of their reconnaissance and relay appropriate instructions for the movement of the main body. The team chiefs organize the vehicles as suggested by the section sergeants. Team vehicles use movement techniques dictated by the factors of METT-TC and unit SOP.

OCCUPY, ORGANIZE, AND IMPROVE POSITIONS

B-21. The occupation of a position should be coordinated with the supported unit to avoid mutual interference. When the section (two teams) arrives at the position, all vehicles move off the road into the position without halting and without closing the interval between vehicles. The unit SOP should state the requirements and the priorities for occupying positions.

B-22. When all teams have reported they are in position and capable of broadcasting air track data to their assigned divisional AMD batteries and assets, the section sergeants will report the section "ready for action."

B-23. Team chiefs begin improving positions as dictated by SOP or additional orders. A typical improvement sequence may include:

- Natural camouflage. Supplement existing camouflage nets where possible with indigenous materials (branches, leaves, and snow). These materials should be from the vicinity of the section so they will blend naturally into the surroundings.
- Cover. The Sentinel teams must dig individual fighting positions when the threat situation dictates. Engineer support may be required in some situations, and should be requested through the divisional AMD battery.
- Alternate and supplementary positions. Work on alternate and supplementary positions is initiated as early as possible to ensure they are available should the primary become untenable.

B-24. Upon occupying the position, the Sentinel teams must provide continuous local security. Obstacles such as a hasty protective minefield provide security, which block, disrupt, or canalize enemy attacks. All obstacles must be coordinated with the battery. Other measures taken should also be integrated with the ground defense plan.

Appendix C

Continuity of Operations

This appendix describes the continuity of operations mode which may be necessary due to equipment failure or battle damage. When a system/subsystem fails, it must quickly reconfigure, to the best of its ability, to allow the mission to continue. All divisional AMD Sentinel teams need to be familiar with the capabilities of the system/subsystem under continuity of operations. Equipment failure may occur when individuals perform maintenance. For example, during extended hours of operation, maintenance lights and indicators will require a soldier's attention. Equipment failure will also occur when engines fail, radios overheat, matching units fail, and soldiers are incapacitated. These make the unit less than 100% (degraded) operational. The battalion tactical standing operating procedures (TSOP) should identify possible continuity of operation situations and degraded modes affecting the Sentinel C² node, radar, and associated equipment.

SENTINEL

C-1. There are numerous continuity of operation scenarios to think about at the Sentinel radar and C² node. The following are possibilities dealing with equipment losses.

RADAR OUT OF ACTION/C² NODE OPERATIONAL

C-2. When the radar is out of action, but the C² node is functioning, ensure that the "Intra-SHORAD" net is active and continuing to exchange track data from other Sentinels in the battalion. Ensure that all fire units are within the active/operating Sentinel's area for Sentinel broadcast. In this scenario, you will be able to broadcast the division air picture but not your own local air tracks.

RADAR OPERATIONAL/C² NODE OUT OF ACTION

C-3. When the C² node is out of action, and the Sentinel radar is still operational, take the C² node EPLRS out of the node and use it at the radar. This will curtail an 8-10 minute EPLRS reactivating needlines delay.

C-4. The Sentinel radar is now in the continuity of operations mode and will broadcast air track data to the battery, platoons, sections, and fire units. If the C² node EPLRS radio is not available (unserviceable) then use the EPLRS radio with the Sentinel to broadcast air track data to the battery, platoons, sections, and fire units. There will be an 8-10 minute wait until the needlines are activated.

RADAR AND C² NODE BOTH OUT OF ACTION

C-5. This condition could exist when the C² node with radar is changing locations. In this case the battery, platoons, sections, and fire units operating in that Sentinel's broadcast zone will not receive an EW air picture. Thus, per

established SOP, the battery, platoons, sections, and fire units need to select another Sentinel C² node.

C-6. Each soldier having a TCU/EPLRS and HTU/EPLRS and not receiving an air picture must accomplish a needline procedure. This procedure requires the operator at the battery to access the LINK TOGGLE menu screen and the platoons, sections, and fire units to access the SETUP menu screen. They position the cursor to SENTINEL BROADCAST and select the Sentinel identified to be used per SOP when continuity of operations occurs.

Note: MANUAL will cause a reboot which cleans out old HTU data. **When the cursor is at MANUAL, do not press ENTER.** Going into or coming out of MANUAL will cause a reboot.

Note: A Sentinel can display and distribute the air picture to another Sentinel if and when one is out of range or line of sight from the ABMOC. This is accomplished when in the "Sentinel Chaining", not the SIM training mode.

SINGGARS

C-7. There are *two* major continuity of operations conditions which would dictate special procedures and configurations concerning SINGGARS digital communications. One is due to distances involved between the Sentinel/C² nodes and the ABMOC in the IntraSHORAD-SINGGARS net and not all Sentinel/C² nodes can receive data from the ABMOC. The second is when not all divisional AMD elements serviced by a Sentinel/C² node-SINGGARS net(s) are receiving the air picture.

C-8. IntraSHORAD-SINGGARS net. The operational deployment of stations on the IntraSHORAD-SINGGARS net is such that not all SINGGARS stations can receive digital data communications from the ABMOC (normal condition). Some Sentinel/C² subsystems can receive from the ABMOC, others cannot. Some are within the planning distance for communications with the A²C² subsystem. When this condition exists, extraordinary communications configurations must be adapted. A solution follows:

- Establish two separate and distinct IntraSHORAD-SINGGARS nets. IntraSHORAD-SINGGARS Net-1 would be established for the ABMOC and Sentinel/C² nodes which can receive from the ABMOC. IntraSHORAD-SINGGARS Net 2 would be established for the A²C² subsystem node and Sentinel/C² nodes which can receive from the A²C² subsystem.
- The DLRP and supported unit boundary (SUB) would be passed via voice communications from the ABMOC to the A²C² subsystem node for dissemination on the IntraSHORAD-SINGGARS Net-2.
- Battlefield geometries, weapons control orders, airspace control measures, and air defense warnings would be passed via JTIDS net. Figure C-1 shows continuity of operations broadcast nets.
- Another possible workaround would be to use a handheld subsystem that is in position to act as a relay as a method of completing this data link. The selected handheld subsystem then would have to communicate on the same frequency/hopset as is being used by the IntraSHORAD-

SINGGARS Net. A consideration for this technique would be only the externally acquired air tracks would be displayed at the selected relay.

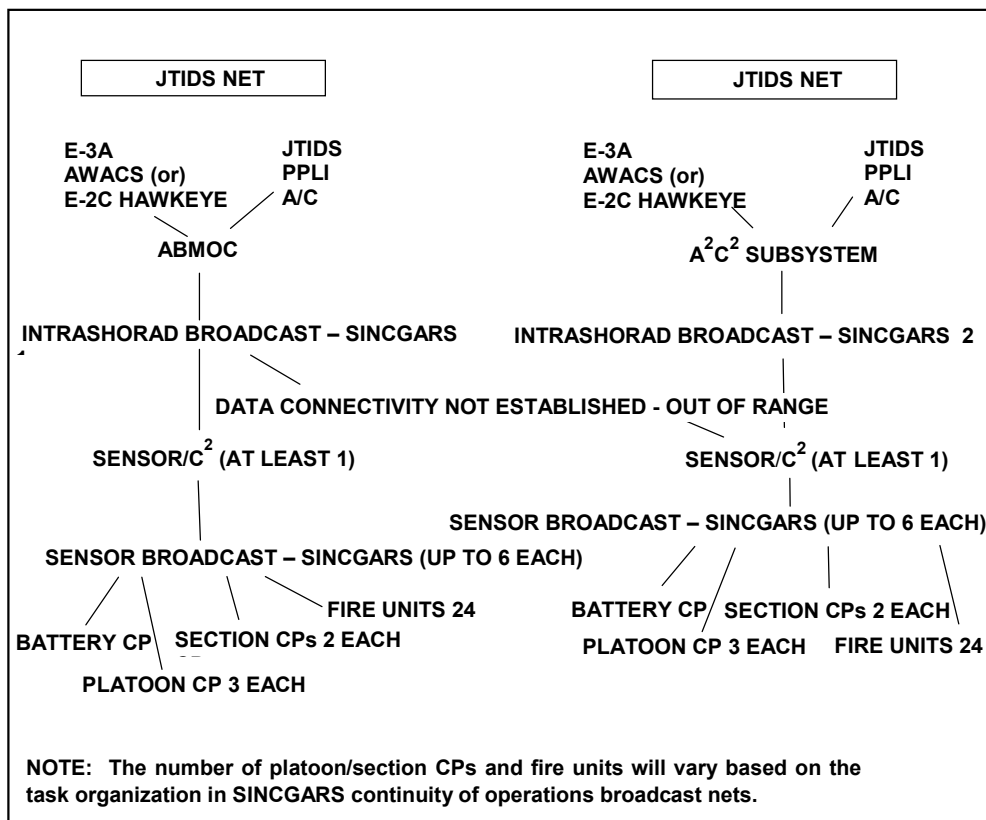

Figure C-1. Continuity of Operations Broadcast Nets

C-9. In the second condition when not all of the battery CP subsystems (and all subsystems subordinated to the battery CP) can receive data from the Sentinel/C² serving as the data interface, a SINGGARS relay is needed. A selected platoon/section CP or fire unit subsystem may be designated as a relay for data received from the Sentinel/C² subsystem. The following constraints would apply in implementing a SINGGARS relay:

- Only one SINGGARS relay is normally allowed per each Sentinel broadcast SINGGARS Net.
- There is only one radio transmitting data over a net at any one time. Only the Sentinel/C² subsystem and the designated relay are to transmit data. The divisional AMD C³I software controls the time for transmission of data.
- This is a special divisional AMD C³I HTU relay using one SINGGARS receiver/transmitter (RT) with the relaying HTU using the same RT and hopset but delaying the time of transmission to the second 2 seconds of the “2+2+2”. It is different than the SINGGARS RT to RT relay where one SINGGARS RT is cabled to another (which relays the data slightly delayed on a second frequency net).

- Because the SINGGARS RT to RT relay destroys the timing of 2+2+2 or 2+2, it should not be used for divisional AMD data. See Figure C-2.

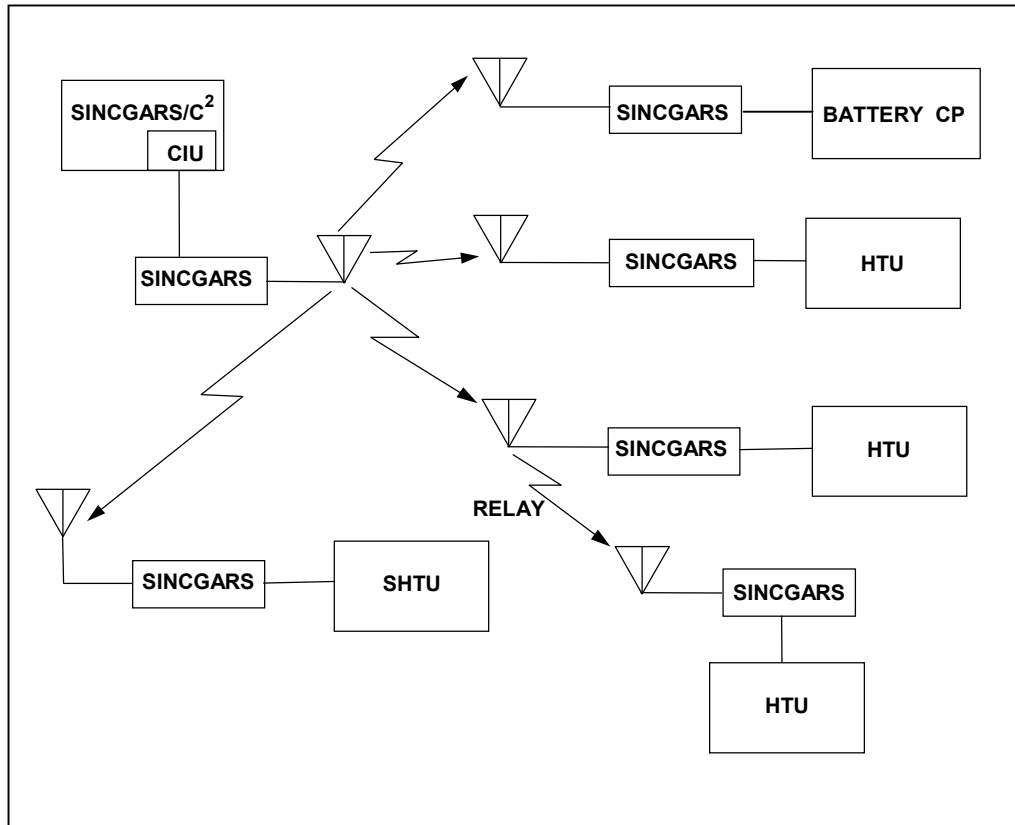

Figure C-2. SINGGARS Relay

Appendix D

Sentinel Management Checklists

The checklists in this appendix are recommended for use by the Sentinel platoon leader, platoon sergeant, and section leaders. They are not all-inclusive; however, they are useful in most combat situations. Additions can be made to these checklists where required. If the battalion or battery SOP calls for different or more detailed procedures, follow the local SOP.

CHECKLIST 1. PLATOON PRECOMBAT INSPECTION	
INDIVIDUAL SOLDIER READINESS	
1. TA-50 inventory.	_____
2. Assigned weapons cleaned and zeroed.	_____
3. Assigned NBC mask with accessories.	_____
4. Load-bearing equipment (LBE).	_____
a. First aid pouch with dressing.	_____
b. Canteen(s) with water.	_____
c. Ammo pouch with magazines.	_____
d. Decontamination kit.	_____
EQUIPMENT READINESS	
1. Publications for vehicles.	_____
2. Logbook, dispatch, and drivers license.	_____
3. Before-operation PMCS and daily operations completed per TMs/FMs.	_____
4. General	
a. Orders and rehearsals conducted.	_____
b. Required package product on-hand.	_____
c. Basic issue items present and serviceable.	_____
d. Fuel can(s) filled.	_____
e. Water can(s) filled.	_____
f. Necessary maps on-hand.	_____
g. Rations distributed.	_____
h. Vehicles loaded per load plan.	_____
i. Compasses on-hand.	_____
j. All necessary manuals on-hand.	_____
COMMUNICATIONS EQUIPMENT	
1. All necessary (supported force, AD, et cetera) TACSOP and SOIs on-hand.	_____
2. Radios and intercom operational.	_____
3. All connectors and receptacles clean.	_____
4. Grounding straps secure.	_____
5. Antennas and matching units complete and serviceable.	_____
6. Field telephones present and serviceable.	_____
7. Applicable batteries on-hand.	_____
8. Radios complete and operational.	_____
9. COMSEC equipment (ANCD) operational and programmed.	_____
10. PLGR operational.	_____

Figure D-1. Checklist 1

<p>WEAPONS</p> <ol style="list-style-type: none"> 1. Weapons cleaning equipment on-hand. _____ 2. All weapons clean. _____ 3. Ammo basic load on-hand and clean. _____ <p>SAFETY</p> <ol style="list-style-type: none"> 1. Road crossing equipment (warning triangles, safety vest, and flashing lights) present and in good working order. _____ 2. Appropriate local area safety briefing given. _____ 3. Vehicle safety check performed. _____ 4. First aid kits or aid bag inspected. _____

Figure D-1. Checklist 1 (Continued)

<p style="text-align: center;">CHECKLIST 2. PLATOON LEADER'S PLANNING</p> <ol style="list-style-type: none"> 1. Threat analyzed. _____ 2. IPB aerial and ground portion reviewed. _____ 3. Air indicator templates, named areas of interest, target areas of interest, and priority avenues of approach reviewed. _____ 4. Battalion decision support template and decision support matrix reviewed. _____ 5. Early warning data frequencies for Sentinels received by batteries. _____ 6. Mission analyzed. _____ 7. Mission focus on the supported brigade force reviewed. _____ 8. Maneuver S3 coordination for all friendly airspace users (especially maneuver scout-launched UAVs and RPVs used for intelligence gathering). _____ 9. Counter-RISTA and the following reviewed: <ol style="list-style-type: none"> a. Predictive operations considerations. _____ b. Convoy. _____ c. Choke points. _____ d. Troop and logistics concentrations. _____ e. APOD and SPOD. _____ f. Considerations for decisive operations. _____ g. Passage of lines. (EW frequencies) _____ h. Movement to contact. _____ i. Meeting engagement. _____ j. Deliberate attack. _____ k. Defend in sector. _____ l. Defend BP and strong point. _____ m. Withdrawal. _____ <p>BACKWARD PLANNING</p> <ol style="list-style-type: none"> 1. Equipment emplacement time. _____ 2. Movement time from rally/release point (RP) to position. _____ 3. Convoy time. _____ 4. Start point (SP) time. _____ 5. Briefing time to section sergeants/team chiefs. _____ 6. Ammunition, POL, and ration resupply plan. _____ 7. Maintenance completion time. _____ 8. Movement time to rally point. _____ 9. March order time. _____

Figure D-2. Checklist 2

10. Reconnaissance time _____
- a. Primary route. _____
 - b. Alternate route. _____
11. Time to pass warning order (WARNO). _____
12. Receipt of order. _____

Figure D-2. Checklist 2 (Continued)

CHECKLIST 3. LIGHT FIGHTER

1. Air mission brief received. _____
2. Airspace users with aviation units coordinated. Primary and alternate command frequency acquired. _____
3. Number of passengers (PAX) transported. _____
4. Number of aircraft to be utilized and time on station. _____
5. Locations of obstacles/special conditions. _____
6. Pickup zone (PZ) control:
 - a. Loads inspected, local security implemented, voice or visual communication with aircraft obtained, obstacles and pickup zone marked. _____
 - b. Flight leader advised of landing direction, wind direction and obstacles. _____
7. Landing zone (LZ) control
 - Local security implemented, voice or visual communications with aircraft obtained, obstacles on LZ marked (if necessary). _____
8. PZ/LZ Teams:
 - Equipment marked, aircraft guided, equipment hooked up, internal load (if any), assisted, checked for obstacles. _____
9. Safety:
 - Ground reconnaissance conducted, PZ/LZ properly marked, and PAX consolidated 100 meters to the left of the aircraft. _____
10. Situation:
 - Frontline trace (enemy, enemy air capability, enemy ADA capability, weather). _____
11. Mission:
 - Mission statement includes who, what, when, why, and where. Includes the command and support relationship and priority. _____
12. Execution:
 - a. Platoon leader's concept of operation:
 - Visualization of the execution from start to completion. _____
 - Support of maneuver forces, stationary asset(s), convoy, et cetera. Includes the overall plan and missions of the platoon. _____
 - b. Platoon leaders intent for the operation:
 - Scheme of maneuver. _____
 - Fire support. _____
 - Missions to divisional AMD assets (air cavalry, attack, lift, Chinook CH-47, pathfinders, et cetera). _____
 - c. Coordinate instructions:
 - Pickup zone(s). _____
 - Name/number. _____
 - Coordinates. _____
 - Load time. _____
 - Takeoff time. _____

Figure D-3. Checklist 3

- Markings. _____
- Control. _____
- Landing formation. _____
- Approach/departure direction. _____
- Alternate PZ name/number. _____
- Aircraft load/sling load. _____
- Penetration points. _____
- Extraction PZ, LZ(s). _____
- Name and number. _____
- Coordinates. _____
- H-hour. _____
- Markings. _____
- Control. _____
- Landing formation and direction. _____
- Alternate LZ name and number. _____
- LAAGER site:
 - Communications. _____
 - Security force. _____
 - Flight routes and alternates. _____
 - Possible abort criteria. _____
 - Cross forward line of own troops (FLOT) operations. _____
 - Aircraft speed. _____
 - Aircraft altitude. _____
 - Aircraft crank time. _____

13. Service Support:

- a. Forward area rearm/refuel points. _____
- b. Rations. _____
- c. POL. _____
- d. Water. _____
- e. Ammunition control. _____
- f. Ammunition supply point locations. _____
- g. Communication contact teams. _____
- h. Maintenance:
 - Motors. _____
 - AMD systems. _____
 - Uniform and equipment. _____
- j. Method of handling sick and wounded. _____
- k. Prisoners of war. _____

14. Command and Signal:

- a. Chain of command and locations. _____
- b. Locations of headquarters. _____
- c. Command posts and alternate command posts.
 - Battery. _____
 - Platoon. _____
 - Supported unit command posts. _____
 - d. Supported unit call signs. _____
 - e. Automated network control device (ANCD). _____
 - f. Identification friend or foe (IFF) mode IV. _____
 - g. Time zone. _____
 - h. Early warning digital frequencies. _____

Figure D-3. Checklist 3 (Continued)

CHECKLIST 4. PLATOON SERGEANT

MONITOR PLATOON OPERATIONS

1. Obtain, copy, and distribute graphics (maneuver, obstacle, combat service support (CSS), and Army airspace command and control (A²C²). _____
2. Plan Sentinel employment. _____
3. Disseminate intelligence. _____
4. Monitor divisional AMD battery planning, preparation, and execution. _____
5. Advise Sentinel platoon leader on status of platoon to include personnel and sensitive items (focusing on classes I, III, and V). _____
6. Provide early warning (EW) digital frequencies to divisional AMD assets. _____

MAINTAIN SITUATION AWARENESS

1. Operation order (OPORD) on-hand and understood. _____
2. Warning order (WARNO) on-hand and understood. _____
3. Fragmentary order (FRAGO) on-hand and understood. _____
4. Battalion, battery, and supported unit scheme of maneuver understood by platoon. _____
5. Ensure good security plan during position occupation. _____
6. Know location of battery and supported unit maintenance and collection point (UMCP): current and future. _____
7. Know location of battery and supported unit tactical operations center (TOC) and tactical air control (TAC): current and future. _____
8. Know location of battery and supported unit decontamination sites: current and future. _____
9. Know location of battery and supported unit casualty collection points: current and future. _____
10. Provide locations of Sentinels to divisional AMD assets. _____

PLANNING, PREPARATION, AND EXECUTION

1. Planning
 - a. Assist platoon leader with platoon time line development and enforcement. _____
 - b. Assist platoon leader with developing a sound platoon C² plan. _____
2. Planning and preparation.
 - a. Ensure platoon casualty and vehicle evacuation plan is complete and rehearsed, if time allows. _____
 - b. Class IV distribution plan developed. _____
 - c. Engineer equipment usage management plan. _____
 - d. Assist platoon leader in planning and conducting all rehearsals. _____
 - e. Ensure coordination with batteries for all classes of supply and support. _____
 - f. Ensure a cross-leveling and resupply plan is in place. _____
3. Preparation.
 - a. Supported unit scheme of maneuver. _____
 - b. A²C² measures. _____
 - c. Airspace control plans (ACPs). _____
 - d. Standard use Army aircraft flight route (SAAFRs). _____
 - e. Fire support coordination measures (trigger lines, target reference point [TRP]) are disseminated and understood. Update on maneuver scout UAV launchings. _____
 - f. Conduct platoon sergeant and platoon leader precombat inspections (PCIs). _____
4. Preparation and execution.
 - Be familiar with passive air defense measures. _____
5. Planning, preparation, and execution.
 - Maintain platoon maintenance status. _____

Figure D-4. Checklist 4

6. Execution
 - a. Take action to correct non-mission capable (NMC) vehicles. _____
 - b. Assist platoon leader in adjusting maintenance and or combat losses. _____
 - c. Assist platoon leader in reporting platoon status (Sentinel locations, Classes I, III, and V, et cetera). _____
 - d. Apply priorities of work for Sentinel team. _____
 - e. Set up radar (crew drill standard), C³I node (w/IntraSHORAD net). _____
 - f. Ensure good communication with section sergeant and platoon headquarters, EPLRS/SINCGARS are up and working, report arrival at location per SOP. _____
 - g. Emplace M8 alarm. _____
 - h. Camouflage positions and equipment. _____
 - i. Prepare fighting positions and range cards (continue to improve positions). _____
 - j. Establish team CP. _____
 - k. Perform vehicle, weapon, and communication maintenance. _____
 - l. Operate according to rest plan (team chief will develop a rest plan that allows the team to operate 24 hours). _____

Figure D-4. Checklist 4 (Continued)

CHECKLIST 5. PRIORITIES OF WORK

1. N - Hour:
 - a. Establish security. _____
 - b. Clear area of NBC hazards. _____
 - c. Establish location of divisional AMD elements in broadcast area and zone. _____
 - d. Perform emplacement crew drill. _____
2. Establish and maintain data link with divisional AMD elements.
 - a. Establish communication with battery and ABMOC. _____
 - b. Emplace M8 alarm (150M – combat; 50M - training). _____
 - c. Select alternate position. _____
 - d. Begin range card. _____
3. N + 1:
 - a. Camouflage vehicles, radar, and generators. _____
 - b. Dig hasty individual fighting positions. _____
 - c. Complete range card. _____
4. N + 2:
 - Emplace special equipment as necessary (claymores, concertina wire, et cetera). _____
5. N + 3 to N + 9:
 - Dig in individual fighting positions. _____
6. N - 10 to N + 24:
 - a. Rehearse movement to alternate position. _____
 - b. Establish a sleep/security/maintenance plan. _____
7. N + 24 and beyond:
 - a. Constantly improve position. _____
 - b. Include alternate position and range card improvement. _____

Figure D-5. Checklist 5

CHECKLIST 6. SECTION LEADER BRIEFING

1. Mission. _____
 - a. Divisional AMD battery and assets locations. _____
 - b. Routes and alternate routes. _____
 - c. ADW. _____
 - d. WCS. _____
 - e. ROE. _____
 - f. Hostile criteria. _____
 - g. Platoon rally point and release point. _____
2. Friendly elements in AO.
 - a. Platoon FRAGO/OPORD. _____
 - b. Rehearsal location and time. _____

Figure D-6. Checklist 6**CHECKLIST 7. POSITION OCCUPATION**

1. Sufficiency for Sentinel occupation.
 - a. 360° line-of-sight. _____
 - b. Alternate exit and entrance routes. _____
 - c. Positions must be easily defensible against ground attack. _____
 - d. Good communications with higher, lower, and supported units. _____
 - e. Good observation and line of sight. _____
 - f. Reconnaissance prior to occupation. _____
 - g. Coordination with appropriate S3 prior to occupation. _____
 - h. Area secured prior to occupation. _____
 - i. Listening post and observation post established at main entrance. _____
 - j. NBC detection, monitoring, and survey team check the area prior to arrival. _____
 - k. Ensure a closure report is submitted per SOP. _____
 - l. When necessary establish vehicle dismount point with ground guide. _____
 - m. Place NBC alarms. _____
 - n. Establish occupation time line (consider mission and its relation to scheme of maneuver and supported unit time line). _____
 - o. Fill gaps in the position with individual fighting positions. _____
 - p. Team chief coordinate with the unit to the left and right. _____
 - q. Ensure listening posts and outposts (if applicable) have the following:
 - Cover and concealment. _____
 - Communications. _____
 - Range card. _____
2. Plan and conduct the following:
 - a. Ammunition resupply. _____
 - b. POL resupply. _____
 - c. Water resupply. _____
 - d. Ration resupply and feeding. _____
 - e. Maintenance support. _____
 - f. Evacuation plan. _____

Figure D-7. Checklist 7

- g. Necessary reports submission. _____
- h. Noise, light, and litter discipline. _____
- 3. Brief Sentinel team on:
 - a. Tactical situation. _____
 - b. Mission. _____
 - c. Challenge and password. _____

Figure D-7. Checklist 7 (Continued)

- CHECKLIST 8. PLATOON COORDINATION**
- Coordinate with maneuver S3 and obtain:
- Commander's intent. _____
 - Frontline trace (operations overlay). _____
 - Friendly air and ground situation. _____
 - Mission. _____
 - Task force rehearsal location and time. _____
 - Current enemy situation, IPB (air and ground) requirements from maneuver S2. _____
 - Administrative and logistics operations from S1 and S4. _____
 - Personnel reporting and replacement procedures. _____
 - Maintenance and vehicle recovery. _____
 - Rations and water resupply. _____
 - Casualty evacuation. _____
 - Ammunition resupply. _____
 - POL resupply. _____
 - NBC situation and location of decon points from the maneuver NBC officer. _____
 - Current SOI requirements and changes. _____
 - Radio replacement procedure. _____
 - Current COMSEC requirements and changes. _____

Figure D-8. Checklist 8

- CHECKLIST 9. PLATOON COMMAND POST**
1. Observe COMSEC/ECCM procedures:
 - a. Enter net according to unit SOI procedures. _____
 - b. Establish platoon net. _____
 - c. Enforce net discipline. _____
 - d. Ensure all required reports are identified and submitted in a timely manner. _____
 - e. Establish maintenance recovery procedures for platoon. _____
 - f. Ensure logistical resupply of the platoon occurs. _____
 - g. Ensure all CP supplies are on-hand. _____
 - h. Know current SOI and authentication passwords. _____
 - i. Know and display on map the current locations of all Sentinel teams. _____
 - j. Ensure platoon sergeant is briefed on plans and operations so he can take over in your absence. _____

Figure D-9. Checklist 9

2. Have at a minimum, but not limited to:
 - a. Mission. _____
 - b. Frontline trace. _____
 - c. Friendly air and ground situation. _____
 - d. Enemy air, ground, NBC, and early warning situation. _____
 - e. Location of decontamination points and clean and dirty routes. _____
 - f. Signal operating instructions (SOI) requirements and changes. _____
 - g. Bridging, route, and obstacle information. _____
3. Take corrective maintenance action on down equipment. _____
4. Coordinate with adjacent units. _____
5. Ensure sections with non-operational equipment still observe cover and concealment. _____
6. Camouflage disabled vehicles. _____
7. Ensure all teams perform PMCS on equipment. _____
8. Ensure security measures are taken for classified documents and other sensitive items per unit SOP. _____
9. Ensure platoon members have the necessary means to keep clean and perform personal hygiene daily. _____

Figure D-9. Checklist 9 (Continued)

CHECKLIST 10. PLATOON OPERATION PLANNING PHASE

1. Apply 1/3-2/3 rule to the teams. _____
2. Perform backward planning. _____
3. Consider factors of METT-TC in planning. _____
4. Present recommendations to commander or S3 regarding allocation of Sentinel teams. _____
5. Actively participate with battalion or battery staff during planning process. _____
6. Plan platoon rehearsal (location, time, and duration). _____
7. Properly analyze enemy air avenues of approach. _____
8. Ensure Sentinel plan compensates for maintenance and combat losses. _____
9. Ensure Sentinel plan supports commander's scheme of maneuver and intent. _____
10. Plan for contingencies. _____
11. Plan for Sentinel team refuel and maintenance. _____
12. Plan for Sentinel teams in assembly areas. _____
13. Discuss early warning to the maneuver force. _____
14. Address with the task force the employment of air guards and engaging enemy air with organic weapons. _____
15. Perform adequate reconnaissance to position occupation. _____
16. Make provisions for alternate and secondary positions. _____
17. Plan medical evacuation of casualties through AMD battery. _____

PREPARATION PHASE

1. Brief all personnel on the OPORD. _____
2. Extract or address pertinent elements of supported unit OPORD in platoon OPORD. _____
3. Move personnel into position or perform face-to-face coordination for Sentinel employment. _____
4. Verify that Sentinel personnel use proper camouflage. _____
5. Verify that Sentinel personnel are prepared to broadcast track data at first light. _____

Figure D-10. Checklist 10

<p>6. Verify that precombat checks and PMCS are accomplished. _____</p> <p>7. Verify that Class III and V uploads are accomplished in a timely manner. _____</p> <p>8. Check Sentinel coverage of battery road march and preparation. _____</p> <p>9. Verify complete dissemination and understanding of OPORDs with backbriefs. _____</p> <p>10. Verify that Sentinel sections conduct initial and ongoing liaison. _____</p> <p>11. Check preparation of primary, alternate, and supplementary positions. _____</p> <p>12. Verify request and receipt of engineer support. _____</p> <p>13. Template actual divisional AMD coverage. _____</p> <p>14. Conduct rehearsals at all echelons. _____</p> <p>14. Conduct rehearsals at all echelons. _____</p> <p>15. Conduct backbriefs. _____</p> <p>16. Verify Sentinel personnel are dug in. _____</p> <p>17. Verify adjacent unit coordination. _____</p> <p>18. Verify dissemination of engineer obstacle overlay. _____</p> <p>19. Ensure clear lanes and the location of minefields are known. _____</p> <p>20. Conduct coordination for medical evacuation on the ground with supported battery. _____</p> <p>EXECUTION PHASE</p> <p>1. Immediately pass any enemy information to the platoon. _____</p> <p>2. Keep platoon informed on disposition of Sentinel sections and battery. _____</p> <p>3. Maintain adequate communications to facilitate C2. _____</p> <p>4. Ensure Sentinel ground enemy contact reports, situation reports, and spot reports (spotters) are sent in a timely fashion. _____</p> <p>5. Make adjustments to compensate for maintenance and combat losses. _____</p> <p>6. Alert Sentinel platoon to use pre-dug foxholes if enemy artillery is expected. _____</p> <p>7. Alert platoon to properly respond to NBC conditions. _____</p> <p>8. Ensure choke points are properly defended. _____</p> <p>9. Ensure the chain of command communication is up and functioning. _____</p> <p>REORGANIZATION</p> <p>The following must take place when combat losses have occurred.</p> <p>1. Platoon organization reestablished.</p> <p>2. FRAGO issued for follow-on mission.</p> <p>3. Ammunition status reviewed.</p> <p>4. Cross-leveling accomplished.</p> <p>5. Class III supplies obtained.</p> <p>6. Casualties treated and evacuated.</p> <p>7. Battery notified for maintenance support or to pass reports.</p> <p>8. Battery updated on status of personnel.</p> <p>9. Sentinel teams perform PMCS and identify any equipment problems.</p> <p>CONSOLIDATION</p> <p>1. Platoon reestablishes local security.</p> <p>2. Prepares and issues FRAGO for specific tasks or to continue the mission.</p>

Figure D-10. Checklist 10 (Continued)

Glossary

2LT	second lieutenant
A²C²	Army airspace command and control
AA	assembly area
AAA	air avenue of approach
AADSACS	Army air defense surveillance and command and control system
ABMOC	air battle management operations center
A/C	aircraft
AC	air conditioner; alternating current
ACP	airspace control plan
ACR	armored cavalry regiment
AD	air defense
ADA	air defense artillery
ADCS	air defense coordination section
adj	adjacent
admin	administration
ADO	air defense officer
ADSI	air defense systems integrator
ADW	air defense warning
AI	area of interest
air defense	All defensive measures designed to destroy attacking enemy aircraft or missiles in the Earth's envelope of atmosphere, or to nullify or reduce the effectiveness of such attack.
air defense artillery	Weapons and equipment for actively combating air targets from the ground.
alert	A warning signal of a real or threatened danger, such as an air attack; to forewarn; to prepare for action.
AM	amplitude modulation
AMD	air and missile defense
ANCD	automated net control device
AO	area of operations
APOD	aerial port of debarkation
app	appellation
ASB	aviation support battalion

ASMB	area support medical battalion
ATP	ammunition transfer point; allied tactical publication
attn	attention
AVIM	aviation intermediate maintenance
avn	aviation
AWACS	Airborne Warning and Control System
AXP	ambulance exchange point
az	azimuth
BAS	brigade aid station
BCT	brigade combat team
bde	brigade
BDU	battlefield dress uniform
bn	battalion
BOS	battlefield operating system
boundary	A line which delineates surface areas for the purpose of facilitating coordination and deconfliction of operations between adjacent units, formations, or areas.
bounding overwatch	A movement technique used when contact with enemy forces is expected. The unit moves by bounds. One element is always halted in position to overwatch another element while it moves. The overwatching element is positioned to support the moving unit by fire or fire and movement.
BP	battle position
BSA	brigade/battalion support area
btry	battery
BSFV	Bradley Stinger Fighting Vehicle
BTU	British thermal unit
C²	command and control
C²I	command, control, and intelligence
C³	command, control, and communications
C³I	command, control, communications, and intelligence
CADE	corps air defense element
CASEVAC	casualty evacuation
cav	cavalry
cbt	combat
CCIR	commander's critical information requirements

CEW	corps early warning
CHS	combat health support; common hardware/software
CIU	control indicator unit
COA	course of action
COCOM	combatant command
COMMZ	communications zone
COMSEC	communications security
CP	command post; check point
CRC	control and reporting center
CS	combat support
CSC	combat stress control
CSS	combat service support
CTA	common table of allowances
DA	Department of the Army
DC	District of Columbia; direct current
DED	diesel engine driven
DEW	division early warning
DISCOM	division support command
DIVARTY	division artillery
DLRP	data link reference point
DP	decision point
DS	direct support
DSA	division support area
DSM	decision support matrix
DST	decision support template
DZ	drop zone
EAC	echelons above corps
early warning	Early notification of the launch or approach of unknown weapons or weapons carriers.
ECC	emissions command and control
ECCM	electronic counter-countermeasures
ECIU	electronic computer interface unit
ECM	electronic countermeasures
EMCON	emission control

enr	engineer
EPLRS	enhanced position location reporting system
EPW	enemy prisoner of war
ETKD	electronic transfer keying device
ETRAC	enhanced target range acquisition and classification
EW	early warning
F	Fahrenheit
FAAD	forward area air defense
FARP	forward arming and refueling point
FAS	forward aid station
FASCAM	family of artillery scattered mines
FBCB²	Force XXI battle command brigade and below
FEBA	forward edge of the battle area
fld	field
FLOT	forward line of own troops
fluid	events easily changed or tending to change
FM	frequency modulation; field manual
FMFM	Field Marine Force Manual
FRAGO	fragmentary order
FRG	Federal Republic of Germany
FSB	forward support battalion
FST	forward surgical team
FU	fire unit
FW	fixed wing
GPS	Global Positioning System
GS	general support
GS-R	general support–reinforcing
GVW	gross vehicle weight
HF	high frequency
HMMWV	high–mobility multipurpose wheeled vehicle
hostile criteria	Description of conditions under which an aircraft or a vehicle may be identified as hostile for engagement purposes.
HQ	headquarters
HTU	handheld terminal unit

HVT	high-value target
Hz	hertz
id	identification
IFF	identification, friend, or foe
IPB	intelligence preparation of the battlefield
JMEM	joint munitions effectiveness manual
JTF	joint task force
JTIDS	joint tactical information distribution system
KIA	killed in action
km	kilometer
kw	kilowatt
LADW	local air defense warning
laager	a defensive encampment encircled by armored vehicles or to camp in a defensive encirclement
lb	pound
LBE	load-bearing equipment
LC	line of communication
LD	line of departure
ldr	leader
LID	light infantry division
LLAPI	low level air picture interface
LNO	liaison officer
log	logistics
LOGPAC	logistics package
LOS	line of sight
LRP	logistics release point
LZ	landing zone
MACOM	major Army command
maint	maintenance
MANPADS	man-portable air defense system
MBA	main battle area
MCWP	Marine Corps Warfighting Publication
MDMP	military decision making process
MEDEVAC	medical evacuation

METL	mission–essential task list
METT-TC	mission, enemy, terrain, troops, and time available (civil)
MGRS	military grid reference system
MICAD	multipurpose integrated chemical agent detector
min	minute
MINTERM	miniature terminal
mm	millimeter
MMC	materiel management center
MOPP	mission-oriented protective posture
MOS	military occupational specialty
MOUT	military operations on urbanized terrain
MP	military police
MPH	miles per hour
MSB	main support battalion
MSE	mobile subscriber equipment
MSR	main supply route
MTF	medical treatment facility
MTOE	modified table of organization and equipment
NAI	named area of interest
NATO	North Atlantic Treaty Organization
NBC	nuclear, biological, and chemical
NL	no limit
NMC	non-mission-capable
NOE	nap–of–the–earth
obj	objective
O/I	operations and intelligence
OP	observation post
OPCON	operational control
OPLAN	operation plan
OPORD	operation order
org	organization
PA	physician’s assistant
pax	passengers
PCC	precombat checks

PCI	precombat inspections
PFC	private first class
PJHI	PLRS-JTIDS-hybrid interface
PLGR	precision lightweight GPS receiver
PLRS	position location reporting system
plt	platoon
PMCS	preventive maintenance checks and services
POL	petroleum, oils, and lubricants
PPLI	precise participant location information
PRF	pulse repetition frequency
PSG	platoon sergeant
PSYOP	psychological operations
pt	point
PUP	pop-up point
PVNTMED	preventive medicine
PZ	pickup zone
R	reinforcing
RF	radio frequency
RISTA	reconnaissance, intelligence, surveillance, and target acquisition
RF	radio frequency
ROE	rules of engagement
RP	rally point; release point
RPM	revolutions per minute
RPV	remotely piloted vehicle
R&S	reconnaissance and surveillance
RSOP	reconnaissance, selection, and occupation of position
R/T	receiver/transmitter
RTD	return to duty
RTO	radio telephone operator
RW	rotary wing
S-1	Personnel Officer
S-2	Intelligence Officer
S-3	Operations and Training Officer
S-4	Supply Officer

SAAFR	standard use Army aircraft flight route
SBS	Sentinel broadcast sector
SBZ	Sentinel broadcast zone
SCS	simulation control source
SEAD	suppression of enemy air defense
sec	section
SF	special forces
SFC	sergeant first class
SFMS	special forces medical sergeant
SGT	sergeant
SHORAD	short-range air defense
SHTU	simple handheld terminal unit
SIDPERS	Standard Installation/Division Personnel System
SIM	simulated
SINCGARS	single-channel ground and airborne radio system
SITEMP	situation template
SMCT	soldier's manual of common tasks
SME	subject-matter expert
SOCM	special operations combat medic
SOI	signal operation instructions
SOP	standing operating procedures
SP	start point
SPC	specialist
SPF	special forces
SPOD	seaport of debarkation
sqdn	squadron
SSG	staff sergeant
STANAG	standardization agreement (NATO)
STP	soldier training publication
SUB	supported unit boundary
TAC	tactical air control
TACON	tactical control
TADIL	tactical digital information link
TAI	target area of interest

TB	technical bulletin
TBP	to be published
TCU	tactical computer unit
TF	task force
TM	technical manual; team
TO	theater of operations
TOC	tactical operations center
TRADOC	US Army Training and Doctrine Command
trans	transportation
TRNS	trains
TRP	target reference point
TSOP	tactical standing operating procedures
TTP	tactics, techniques, and procedures
TX	Texas
UAV	unmanned aerial vehicle
UMCP	unit maintenance collection point
US	United States
UTM	universal transverse mercator
w/	with
WARNO	warning order
WBGT	wet bulb globe temperature
WCS	Weapon control status. The degree of fire control imposed upon Army units having assigned, attached, or organic air defense weapons.
w/e	with equipment
WIA	wounded in action
wpn	weapon
XO	executive officer

Bibliography

- DA Form 5188-E. *Equipment Inspection Maintenance Worksheet*. 00 March 1991.
- FM 3-3. *Chemical and Biological Contamination Avoidance (FMFM 11-17)*. 16 November 1992 (Change 1 dated 29 September 1994).
- FM 3-4. *NBC Protection (FMFM 11-9)*. 29 May 1992 (Change 2 dated 21 February 1996).
- FM 3-5. *NBC Decontamination (MWCP 3-37.3)*. 28 July 2000 (Change 1 dated 31 January 2002).
- FM 3-100. *Chemical Operations Principles and Fundamentals (MCWP 3-3.7.1)*. 8 May 1996.
- FM 7-8. *Infantry Rifle Platoon and Squad*. 22 April 1992 (Change 1 dated 01 March 2001).
- FM 8-10-6. *Medical Evacuation in a Theater of Operations Tactics, Techniques, and Procedures*. 14 April 2000.
- FM 8-10-25. *Employment of Forward Surgical Teams Tactics, Techniques, and Procedures*. 30 September 1997.
- FM 21-10. *Field Hygiene and Sanitation*. 21 June 2000.
- FM 44-43. *Bradley Stinger Fighting Vehicle Platoon and Squad Operations*. 3 October 1995.
- FM 44-44. *Avenger Platoon, Section, and Squad Operations*. 3 October 1995.
- FM 44-64. *SHORAD Battalion and Battery Operations*. 5 June 1997.
- FM 44-100. *US Army Air and Missile Defense Operations*. 15 June 2000.
- FM 63-23. *Aviation Support Battalion*. 6 June 1996.
- FM 100-14. *Risk Management*. 23 April 1998.
- FM 101-5. *Staff Organization and Operations*. 31 May 1997.
- Joint Publication 1-02. *Department of Defense Dictionary of Military and Associated Terms*. 12 April 2001 (as amended through 14 August 2002).
- Operational Concept Document. *FAAD C3I System/Subsystem*. 9 July 1999.
- STANAG 2014. *Formats for Orders and Designation of Timings, Locations and Boundaries*. Edition 9. 17 October 2000.
- STANAG 2019. *Military Symbols for Land Based Systems—APP-6(A)*. Edition 4. 18 December 2000.
- STANAG 2241. *Land Operations—ATP-3.2*. Edition 1.
- STANAG 3880. *Counter Air Operations [ATP-42 (B)]*. Edition 3. 12 June 1996.
- STP 21-1-SMCT. *Soldier's Manual of Common Tasks Skill Level 1*. 31 August 2003.
- STP 21-24-SMCT. *Soldier's Manual of Common Tasks Skill Levels 2–4*. 31 August 2003.
- STP 44-14J14-SM-TG. *Soldier's Manual and Trainer's Guide, Skill Levels 1, 2, 3, and 4, MOS 14J, CAI Tactical Operations Center/Enhanced Operator/Maintainer*. 25 November 2002.

TB 11-7010-305-10. *Operator's Manual for Communication Control Sets AN/TSQ-182A, AN/TSQ-182B, AN/TSQ-183B, AN/TSQ-183C, AN/TSQ-183D, AN/TSQ-184C, AN/TSQ-184D, AN/TSQ-184E, and AN/TSQ-184F (Subsystems of FAAD C2I Systems)*. 15 December 2001.

INDEX

A

AADSACS, 1-16

aerial

- IPB, 2-1, 3-5, D-2, D-8
- platform, 1-16, B-2
- port of debarkation, D-2
- reconnaissance, B-1, B-2
- surveillance, 3-8

air and missile defense

- annex, A-1, A-3
- assets, 1-16, 2-10, 4-6, B-3, D-3, D-3
- configuration of, 2-13
- direct support, 2-5, 2-6, 2-11, 4-5, 4-11
- divisional, 1-1, 1-7, 1-12, 1-13, 2-1, 2-2, 2-12, 2-13, 3-1, 3-2, 3-5, 3-7, 3-10, 4-1, 4-4, 4-5, 4-7 thru 4-9, B-1 thru B-5, C-1 thru C-4, D-3, D-5 thru D-7, D-10
- employment principles, 2-2, 2-3
- orders, A-1 thru A-7
- plan, A-4, A-5
 - systems, 1-1, 2-2, 2-3, 2-8, 2-9, 2-15, 3-7, 3-10, D-4
- workstation, 2-9, 2-15

air track script, 2-13

airborne and air assault operations, 3-12

area defense, 3-7 thru 3-10

area of interest (AI), 1-17, 2-8, A-3,

attachment, 2-1, 2-2, 2-4, 2-5, 3-1, 3-6, 4-1, 4-5, 4-8 thru 4-9, 4-16, A-1, A-3 thru A-5, A-7

attack

- aerial, 3-7, 3-8, 3-14, A-3,
- approach, 2-2
- brigade, 2-15
- deliberate, 3-2, D-2
- demonstration, 3-5
- division, 1-15

feint, 3-4, 3-5

ground, B-4, D-7

hasty, 3-2

in light/special operations, 3-11

in mobile defense, 3-9, 3-10

nighttime air and missile, 2-10

offensive, 3-1 thru 3-5

pop-up, 2-9, 3-5

spoiling, 3-6

B

backbrief, 2-19, D-9, D-10

balanced coverage, 2-3

battlespace, 2-8, 3-11, 3-12

brigade/battalion support area, (BSA), 4-2 thru 4-11

broadcast sector, Sentinel, (SBS), 1-12 thru 1-14

broadcast zone, Sentinel (SBZ), 1-12 thru 1-14, 3-7, 3-10, C-1

C

C² node, iii, 1-2, 1-9 thru 1-13, 3-13, B-4, C-1, C-2

CASEVAC, 1-8, 4-6

checklist

- light fighter, D-3, D-4
- platoon, D-1 thru D-3, D-5, D-6, D-8 thru D-10
- position occupation, D-7, D-8
- priorities of work, D-6
- section leader briefing, D-7

COA, 1-21, 2-8 thru 2-11, 2-15, 2-16

combat trains, 4-3, 4-4

command and control, 1-2, 1-16, 2-1 thru 2-6, 2-19, 3-5, D-5

command and signal, A-1 thru A-3, A-5 thru A-7, B-3, D-4

commander's critical information requirements (CCIR), A-1, A-4

consolidation, D-10

continuity of operations, C-1 thru C-3

coordinating instructions, 2-17, A-1 thru A-5, A-7, B-2

coverage in depth, 2-3

cross-leveling, 4-13, 4-14, D-5, D-10

D

defense in depth, 3-7

defensive operations, 2-1, 2-2, 2-20, 3-1, 3-6 thru 3-11, 4-14

define the battlefield environment, 2-8

deliberate attack, 3-2 thru 3-3, D-2

demonstration, 3-2, 3-4

direct support (DS), 2-5, 2-7, 2-12, 2-16, 4-2, 4-5, 4-11, 4-23

division support command (DISCOM), 4-1 thru 4-3

E

early detection, 2-3

early warning

- AMD force, 2-13
- corps, 1-15
- CP checklist, D-8, D-9
- defensive operations, 3-6 thru 3-11
- digital, 1-1, 1-6, 2-2
- directed, 1-16
- division voice, 1-15
- EPLRS, 1-11 thru 1-13
- frequencies, D-2, D-4, D-5
- maneuver force, 2-2, 2-12, 3-4, D-9
- movement, 2-12, 2-13, 2-17, 3-4
- OPORD, A-3
- SINCGARS, 1-12

EMCON, 2-13
 emergency resupply, 4-11, 4-13
 employment guidelines, 2-3
 ETRAC, 1-10
 execution
 and assessment, 1-21
 area defense, 3-8
 paragraph, A-1 thru A-6, A-7, B-2, B-3, D-3, D-4
 phase, 2-17, D-5, D-10
 planning, 2-1
 exploitation, 3-1, 3-3, 3-5
F
 FAAD C³
 architecture, 1-5
 LLAPI, 1-16, 1-17
 mission, 1-1
 needlines, 1-12
 subject-matter experts, 1-6, 1-8
 support for planning, 2-13
 without ABMOC/A²C², 1-15
 FARP, 2-9, 1-10
 feint, 3-4, 3-5
 field trains, 4-3, 4-4, 4-9, 4-11
 fluid replacement, 1-19
 force protection, 1-8, 1-18, 1-20, 1-21, 2-11, 2-12, 2-16, 2-18, 3-5, 3-12, A-4
 forward support battalion (FSB), 4-1 thru 4-3, 4-16
 fragmentary order (FRAGO), 2-15, 2-17, A-2, D-5, D-7, D-10
G
 general support (GS), 1-8, 1-18 2-1, 2-2, 2-6, 2-7, 2-11, 2-16, 3-6, 3-8, 4-5, 4-11
 general support-reinforcing (GS-R), 2-6, 2-7
I
 IFF, 1-7, A-3, D-4
 inspections, 2-18, 2-20, 4-11, 4-12, D-1, D-5

integration, 2-2, 2-3
 intelligence preparation of the battlefield (IPB), 2-1, 2-3, 2-7, 2-8, 3-1, 3-2, 3-5, 3-8, 3-14, D-2, D-8
J
 JTIDS, 1-9, 1-13, 1-14 2-8, C-2, C-3
L
 light and special operations, 3-11, 3-12
 low-level air picture interface (LLAPI), 1-16, 1-17
 logistics
 attached, 2-5
 classes, 4-1 thru 4-4, 4-7, 4-10, 4-12 thru 4-14, D-5, D-9, D-10
 functional overview, 4-1
 DS, 2-6, 2-7
 GS, 2-6, 2-7
 GS-R, 2-6, 2-7
 obtaining, 4-7, 4-8
 OPCON, 2-5
 planning, 4-1, 4-5, 4-6
 platoon sergeant, 1-8
 raid, 3-3
 reinforcing, 2-6, 2-7
 section sergeant, 1-8, 4-8
 Sentinel, 4-4 thru 4-16
 support, 2-6, 2-13
 TACON, 2-5
 LOGPAC, 4-4, 4-6, 4-8 thru 4-10, 4-12
M
 main support battalion (MSB), 4-1, 4-2
 maintenance
 aviation intermediate, 4-1, 4-3
 before operation, 2-21
 combat trains, 4-3
 coordination, 4-9, D-8
 direct support, 4-2
 equipment failure, C-1, D-9
 field trains, 4-3
 ground, 4-3

holding area, 4-11
 light fighter, D-4
 MSB, 4-2
 officer, 4-4
 planning, D-2, D-5 thru D-7, D-9
 platoon leader, D-5
 platoon sergeant, 1-7, D-5
 recovery, D-8
 reports, 4-10, 4-15
 section, 1-1, 1-2, 1-4, 1-7 4-10
 tool kit, 1-4
 vehicle, 4-12, D-6
 war gaming, 2-10, 2-16
 weapon, 1-18, 1-20
 map
 classified, 4-1
 MEDEVAC, 4-17
 readiness, D-1
 reconnaissance, 2-18, B-1 thru B-4
 rehearsal, 2-20
 supply, 4-1, 4-8
 team locations, D-8
 WARNO, A-1
 mass, 2-2
 MDMP, 2-8, 2-13 A-1
 medical
 aid station, 4-9
 combat trains, 4-3
 echelons of care, 4-2, 4-21 thru 4-23
 evacuation, 4-11, 4-15 thru 4-23, A-4, D-9, D-10
 FSB, 4-2, 4-15
 material, 4-7
 movement order, A-6
 MSB, 4-2

operations center, 4-1
 supplies, 4-1
 METT-TC, 1-8, 1-15, 2-2 thru
 2-4, 2-12, 3-4, 3-6, 4-1,
 4-10, B-2 thru B-5, D-9
 military operations in urban
 terrain (MOUT), 3-12,
 3-13
 mission
 air threat, 2-9
 AMD, 1-1, 2-1, 2-3, 2-6,
 2-10, 4-8, A-3, B-1,
 D-3
 analysis, 2-7, 2-10, 2-14,
 2-16, D-2
 contingency, 2-9
 defense in depth, 3-7
 evacuation, 4-17, 4-18, 4-
 20
 exploitation and pursuit, 3-3
 follow-on, D-10
 higher commander, A-1
 light/special operations,
 3-11 thru 3-14
 paragraph, A-1 thru A-5, A-
 7, B-3, D-3
 receipt, 1-20
 risk to, 1-18 thru 1-23
 Sentinel, 1-1, 1-6 thru 1-8,
 2-3, 2-15, 4-7, B-2, B-
 4, D-3, D-7
 statement, D-3
 supported unit, 2-3, 2-12,
 3-10, 4-6
 tactical, 1-15, B-4
 mix, 2-2, 2-3
 mixed employment, 2-2
 mobile defense, 3-9, 3-10
 mobility, 2-3, 2-13
 mobilization, 4-23
 MOPP, 2-21
 mountain operations, 3-12 thru
 3-14
 mutual support, 2-5

N

named area of interest (NAI),
 2-2, 2-10 thru 2-12, 2-15,
 3-2 thru 3-5, 3-6, 3-8,,
 D-2

nap-of-the-earth (NOE), 2-9

O

offensive operations, 1-18, 2-2,
 3-1 thru 3-5, 3-7, 3-10, 3-13

operation order (OPORD), 2-7,
 2-16 thru 2-19, 2-20, 4-15,
 A-1 thru A-3, B-3, D-5, D-7,
 D-9

operation plan (OPLAN), 2-7,
 A-1, A-4

operational control (OPCON),
 2-5, 2-12, 2-16, 4-9

organizational limitations, 1-9

overlapping coverage, 1-9, 2-4

P

personnel services, 4-15

plan

airspace control, D-5

AMD, A-3

briefing, 1-20, B-3

C², D-5

C³I Sentinel management,
 1-7

EMCON, 2-13

environmental protection,
 1-22

fire control, 1-21

from COA, 2-10

ground defense, B-5

ground reconnaissance,
 B-3

load, D-1

ration resupply, D-2

reconnaissance and survei-
 llance, 1-7, 2-10, 3-1,

rest, D-6

resupply, D-5, D-7

security, B-3, D-5, D-6

tactical, 2-19, 4-4

tentative, 2-17, 2-18

unit evacuation, 4-16

vehicle evacuation, D-5

planning

ADO's role, 2-7, 2-10, 3-8

Thru 3-10, 4-5

area defense, 3-7, 3-8

backward, D-2, D-9

battery CSS, 1-7

checklist, D-2, D-10

communications, 2-12, C-2

considerations, 2-12, 2-13

CSS, 4-1, 4-4, 4-6, 4-8, D-5

division level, 1-6, 2-1, 3-8,

D-5

FAAD C³I, 2-13

limited, 1-8, 1-9

management, 2-1, 2-12

mobile defense, 3-9, 3-10

deadline, 1-11, 1-12

platoon leader, 2-2, 2-12,
 2-13, 2-17, D-2, D-5

safety, 1-20

Sentinel employment, 1-7,

2-1, 2-3, 2-12 thru

2-13, 3-1, 3- thru 3-7,
 3-10 thru 3-12, 3-12,
 4-5, D-5

supported force, 1-6, 1-7,

2-3, 2-10, 2-13

team movement, 2-13, 3-4

vignette, 2-14

platoon

command post, C-3, D-4,

D-8, D-9

configuration, 1-2, 1-14, 2-2
 coordination checklist, D-8
 FRAGO/OPORD, D-7
 headquarters, 1-1, 1-2, D-6
 leader, 1-2, 1-6, 1-7, 1-13,
 1-18, 1-20, 2-1, 2-2,
 2-12 thru 2-21, 4-15,
 A-1, D-1 thru D-3,
 D-5,
 maintenance, D-5, D-8
 mission, D-3
 net, D-8
 operation planning phase
 checklist, D-9, D-10
 OPORD, D-9
 PCI checklist, D-1, D-2
 planning, D-5, D-9
 responsibilities, 1-6 thru 1-8
 resupply, D-8
 sergeant, 1-2, 1-7, 1-8, D-1,
 D-5, D-6, D-8
 precombat inspection (PCI),
 2-20, 4-11, D-1, D-5
 pursuit, 3-1, 3-3, 3-5
Q
 quick view screen, 2-14
R
 radar
 camouflage, D-6
 coverage, 3-8, 3-12, B-2
 emissions, 3-4
 line of sight, 3-13
 masking, 3-12
 continuity of operations,
 C-1, C-2
 sections, 1-5, 1-6
 signature, 2-13
 raid, 2-14, 3-3, 3-4
 reconnaissance

aerial, B-1, B-2
 and surveillance, 1-7, 2-2,
 3-1, A-4
 conduct, 2-17
 deliberate attack, 3-2
 ground, B-1 thru B-4, D-3
 map, 2-18, B-1 thru B-4
 methods, B-1, B-2
 party, B-2, B-3
 team, 2-18, 3-2, 4-13
 time, D-2
 rehearsal
 battery, 2-16
 brigade, 2-16, 4-7
 full-dress, 2-20
 implement controls, 1-21,
 1-23
 limited, 1-8
 location and time, D-7, D-9
 map, 2-20
 MDMP, 1-21
 mounted, 2-21
 PCI, D-1
 platoon sergeant, D-5
 radio, 2-20, 2-21
 sand table, 2-21
 Sentinel participation in,
 4-6, D-10
 task force, D-8
 techniques, 2-19 thru 2-21
 walk-through, 2-18
 reinforcing, 2-6
 replacement operations, 4-15
 D-8
 reorganization, D-10
 resupply, 2-16, 2-21, 4-4, 4-10
 thru 4-14, D-2, D-5, D-7,
 D-8
 retrograde, 3-7, 3-9 thru 3-11

RISTA, 1-1, D-2
 RSOP, B-1 thru B-5
S
 safety, 1-18, 1-19
 sand table, 2-18, 2-21
 scenario generation, 2-13,
 2-14
 SEAD, 2-10
 section
 ABMOC, 1-11, 1-12, 1-14
 attached, 2-1, 2-2, 3-1, 3-6
 command post, B-3, C-3
 DISCOM, 4-1
 GS, 2-1, 2-2
 headquarters, 1-1, 1-2
 logistics challenges, 4-4
 maintenance, 1-1, 1-4,
 4-10
 medical, 4-22
 MOUT, 3-13
 radar, 1-5, 1-6
 sergeant, 1-5, 1-7 thru 1-9,
 1-20, 2-12, 2-16 thru
 2-20, 3-4, 4-4 thru
 4-15, B-1 thru B-5,
 D-2, D-6
 strength report, 4-15
 service station method, 4-10
 thru 4-14
 simulation control source
 (SCS), 2-12, 2-13
 SINCGARS, 1-12, 2-11,
 2-12, 2-15, 2-16, 3-13,
 C-2 thru C-4, D-6
 situation awareness, D-5
 stability and support
 operations, 1-18, 3-12,
 3-14
T
 tactical control (TACON), 2-5
 tailgate method, 4-10 thru 4-12
 target area of interest (TAI),
 2-2, 2-11
 team

ADCS, 1-15
 air tracks, 1-11 thru 1-13
 attached, 1-7, 3-6, 4-7
 chief/sergeant, 1-5, 1-7,
 1-8, 1-10, 1-20, 1-21,
 1-22, 2-1, 2-14, 2-15,
 2-18 thru 2-20, 3-8,
 3-13, 3-14, 4-4 thru
 4-13, 4-15, B-1 thru
 B-5, D-2, D-6, D-7
 CP, 4-9, D-6
 CSS support, 1-9, 2-12, 4-5
 thru 4-12, D-9
 communications contact,
 D-4
 demonstration, 3-4
 digitized C² node, 1-9
 employment, 3-2, 3-5, 3-6,
 3-11, 3-12, 3-13
 exploitation, 3-5
 feint, 3-4
 forward area support, 4-3
 maintenance contact, 4-10
 maneuver, 1-15
 medical, 4-22, 4-23
 movement, 2-12, 2-17, 3-1,
 3-2, 3-6, 3-11, 4-13,
 B-1
 NBC/mine detection, B-3,
 D-7
 overlay, 2-17
 per section, 1-2, 1-5, 2-1,
 3-1, 4-1, B-2, B-5
 preparation, 3-8
 pursuit, 3-3, 3-5
 PZ/LZ, D-3
 raid, 3-4
 reconnaissance, 2-18
 rehearsal, 2-18
 replacements, 4-15
 resupply techniques, 4-10
 thru 4-12
 retrograde, 3-10
 safety, 1-18, 1-19
 supported force, 1-7, 3-12

threat evaluation, 2-9
 training, 1-6, 1-7, 1-18 thru
 1-20, 1-22, 1-23, 2-5, 2-18,
 2-19, 2-20, 4-10, 4-21, 4-22
 troop-leading procedures, 2-16
 thru 2-19
 U
 unit maintenance collection
 point (UMCP), 4-4, 4-9,
 4-10, D-5
 V
 vignette, 2-15, 2-16
 W
 warning order (WARNO), 2-7,
 2-10, 2-11, 2-12, 2-14 thru
 2-17, A-1, B-2, D-3, D-5
 weighted coverage, 2-3

FM 3-01.48
12 DECEMBER 2003

By Order of the Secretary of the Army:

PETER J. SCHOOMAKER
General, United States Army
Chief of Staff

Official:

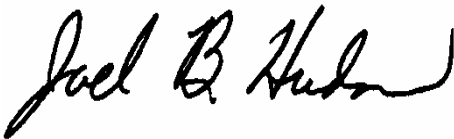
A handwritten signature in black ink that reads "Joel B. Hudson". The signature is written in a cursive style with a large, sweeping initial "J".

JOEL B. HUDSON
Administrative Assistant to the
Secretary of the Army
0332904

DISTRIBUTION:

Active Army, Army National Guard, and US Army Reserve: Not to be distributed.
Electronic means only.

PIN: 081177-000